

VOAD

INTERNATIONAL GROUP



# Catalog of products

At KATREX, our mission is to provide high-quality consumables that help businesses optimize their processes, reduce costs, and eliminate downtime caused by material shortages. We specialize in offering reliable products with consistent availability and timely delivery, so our customers can focus on what truly matters: the productivity and efficiency of their operations.

**Email:** [ventas@vadinternational.mx](mailto:ventas@vadinternational.mx)

**Phone / WhatsApp:** +52 899 458 7476.

**Web page:** [www.vadinternational.mx](http://www.vadinternational.mx)

**Address 1:** Blvd. Hidalgo 1480 Col. del Valle. Reynosa, Tam. México C.P. 88620

**Address 2:** Ramón Rayón 806-6 Zaragoza. Juárez, Chih. México C.P. 32590

## Our products



Cleaning paper



Cleaning cloth



Protective Equipment, Cleanroom Swabs, Pre-moistened Wipes, Spill Control

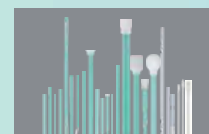

# NEW PRODUCTS

Hot sale



**For details of nano-scale ultra-fine cleanroom wiper**  
Please go to >> P26

Product Model **WG01**



**Island cleanroom wipers**  
Please go to >> P27

Product Model **WI01**



**Metallic wiper**  
Please go to >> P28

Product Model **WZ01**



**Nano polishing wiper**  
Please go to >> P28

Product Model **WR01**



**Island fiber scroll wiper**  
Please go to >> P29

Product Model **WR07**



**Nano Polished Reel wiper**  
Please go to >> P29

Product Model **WR10**



**cleanroom spacer paper (ESD)**  
Please go to >> P33

Product Model **WN12**



**Wafer gasket paper (ESD)**  
Please go to >> P33

Product Model **WN13**



**Antibacterial adhesive pad**  
Please go to >> P37

Product Model **M01**

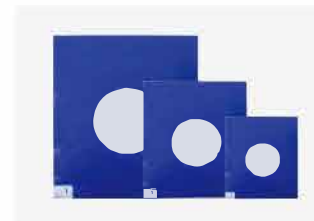

**Open-pore adhesive mat**  
Please go to >> P37

Product Model **M02**

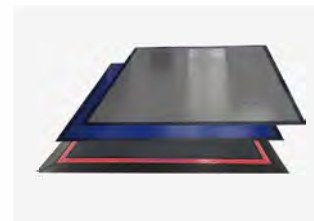

**Washable Silicone Dust Pad**  
Please go to >> P37

Product Model **M03**



**Patterned sticky mat (home)**  
Please go to >> P37

Product Model **M04**



**PE adhesive roller**  
Please go to >> P38

Product Model **M07**



**Machine silicone roller**  
Please go to >> P38

Product Model **M06**



**Crotch zipper hooded jumpsuit**  
Please go to >> P54

Product Model **MSD-03-1**



**Straight pull hooded jumpsuit**  
Please go to >> P57

Product Model **MSD-01-1**



**Medical straight pull hooded jumpsuit**  
Please go to >> P58

Product Model **MSD-01-4Y**



**SMS Knitted Collar Workwear**  
Please go to >> P66

Product Model **PNC-04**



**Strip cap double ribs**  
Please go to >> P68

Product Model **DP-01**



**Anti-static shoe cover**  
Please go to >> P76

Product Model **ASC-001**



**Nitrile gloves for batteries**  
Please go to >> P71

Product Model **MHS09-001**



**Halogen-free nitrile gloves**  
Please go to >> P71

Product Model **MHF12-001**



**Nitrile Gloves (Level 10)**  
Please go to >> P72

Product Model **MRF12-001**



**Anti-static PVC gloves**  
Please go to >> P73

Product Model **MAS09-001**



**Anti-static anti-fatigue floor mat**  
Please go to >> P86

Product Model **MATM-005**



**Anti-static mesh door curtain**  
Please go to >> P87

Product Model **MADC-001**



**Anti-static special tweezers**  
Please go to >> P89

Product Model **MSA-19**



**PU Anti-static Back Chair**  
Please go to >> P92

Product Model **MSD-288**

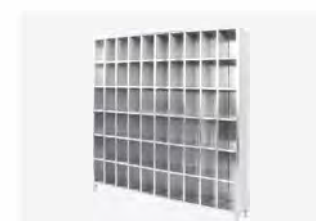

**Water cup holder**  
Please go to >> P98

Material **SUS304**



**Glove dispensing cabinet**  
Please go to >> P98

Material **SUS304**



**Special gas cylinder trolley**  
Please go to >> P99

Material **SUS304**



**Second-story stainless steel trolley**  
Please go to >> P99

Material **SUS304**

## Core Business Segments

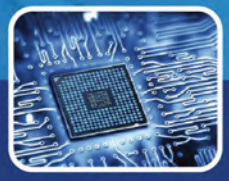
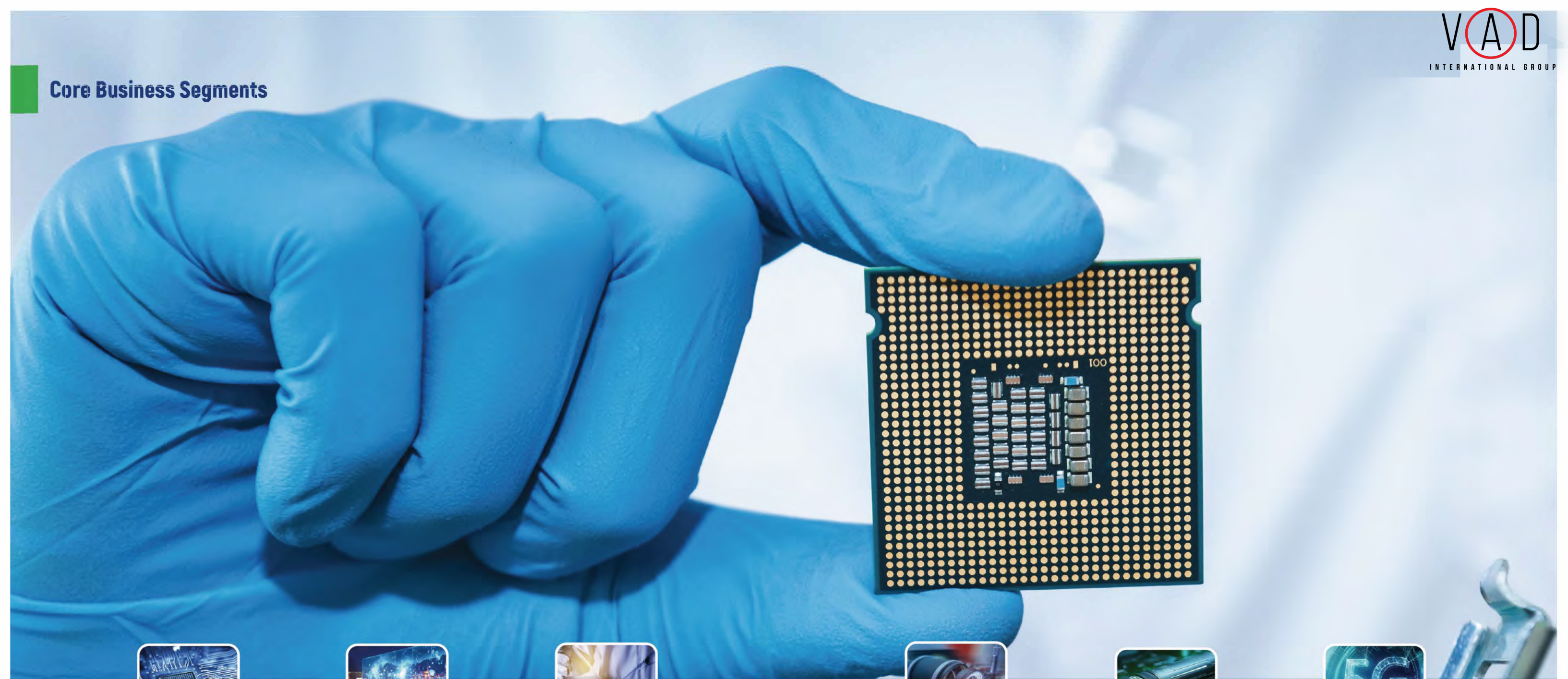

Semiconductor



LCD panel



Biopharmaceutical



Precision electronics

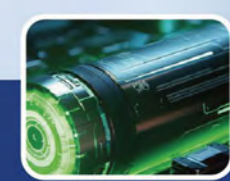

New energy



5G field

Create more convenient, intelligent and green products for customers with innovation and service

# CLEANROOM CONSUMABLES

Wipe more than clean

- Cleanroom wiper series
- Cleanroom nonwoven wiper series
- Pre-wet Cleanroom wiper series
- Sterilized Cleanroom wiper series
- cleanroom office supplies
- Sticky series
- cleanroom purification cotton swab series
- cleanroom mop/wiper series

## • Myesde cleanroom cleaning products: multi-domain adaptation, meticulous research to achieve excellence •

Myesde cleanroom cleaning series products are widely used in semiconductors, biopharmaceuticals, LCD panels, New energy and other key environments and processes that have high requirements for cleanroom cleanliness. Suitable for ISO Class 3-6 clean environments. Myesde main products, high-end precision wiping Cleanroom wipers, are mainly composed of low-oil and low-chlorine polyester knitted fabrics, polyester-nylon ultra-fine knitted fabrics, Made of polyester-nylon woven fabric, it has the characteristics of low particles, low ions and low production of non-volatile residues. We have a team of experts in the fields of textile fabrics and pollutant control, Conduct in-depth analysis, carry out targeted research and development, and strictly audit to provide you with the most effective, ptimum products and solutions and ensure their quality and effectiveness.



## • Selection of edge sealing process of Cleanroom wiper •

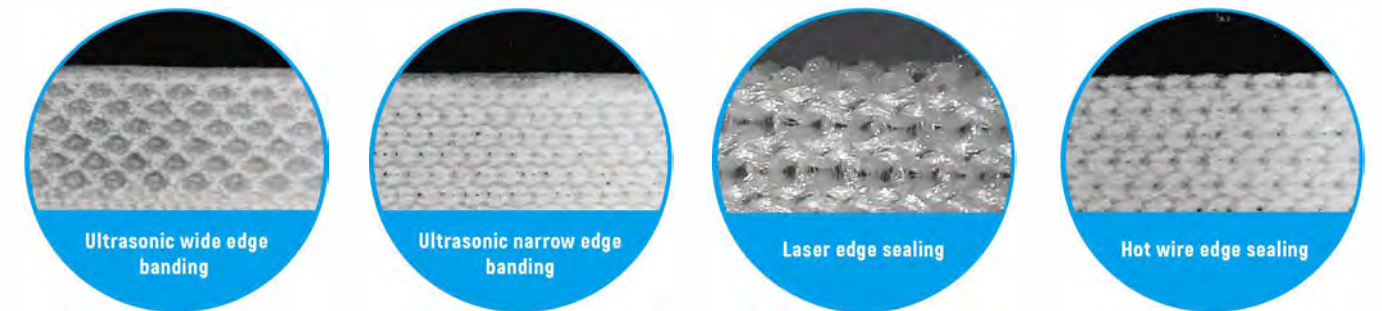

## • ISO14644 International Standard for Clean Room and Related Control Environment •

Maximum concentration limits for airborne particulate cleanliness (per cubic meter, per cubic foot)

ISO 14644-1 ISO Class	FED STD 209E		CLASS	Number of Par Cubic Meter by Micrometer Size						Myesde
	English	Metric		0.1um m <sup>3</sup>	0.2um m <sup>3</sup>	0.3um m <sup>3</sup>	0.5um ft <sup>2</sup>	0.5um m <sup>3</sup>	5um	
1			ISO1	10	2					
2			ISO2	100	26	10		4		
3(Class 1)	1	M1.5	ISO3	1,000	265	106		35		Applicable
4(Class 10)	10	M2.5	ISO4	10,000	2,650	1,060	10	353		Applicable
5(Class 100)	100	M3.5	ISO5	100,000	26,500	10,600	100	3,530	29	Applicable
6(Class 1,000)	1,000	M4.5	ISO6	1,000,000	265,000	106,000	1000	35,300	293	Applicable
7(Class 10,000)	10,000	M5.5	ISO7				10000	353,000	2,930	Applicable
8(Class 100,000)	100,000	M6.5	ISO8				100000	3,530,000	29,300	Applicable
9			ISO9				1000000	35,300,000	293,000	Applicable

\*Class 1 is the highest grade. The smaller the grade, the higher the cleanliness. The products of the corresponding class need to be finished in the clean room of the corresponding grade

To prevent micro-contamination and empower high technology.

- 02 Human protection
- 03 Electrostatic control
- 04 Environmental purification
- Secondary category
- A Cleanroom wiper
- B Cleanroom nonwoven wiper
- C Cleaning Supplies Aids
- D Office supplies series
- E Sticky series
- F Cotton swab series
- G Mop + Mop wiper



**Polyester lightweight Cleanroom wiper**

Model	Specification	Packaging
WL01	120 g/m <sup>2</sup> , hot melt, 9*9 inch	100 pcs/pack

- Good ability to absorb solvents and resist chemicals, compatible with a variety of solvents
- Good wiping performance, which can save the amount of wiping wiper
- Product test according to IEST method, clean the package with 18MΩ DI water in Class 10 clean room

**Application scenarios:**

- Mainly used for cleaning equipment and clean room environments in semiconductors, magnetic heads, hard disks, TFT-LCD, machinery, pharmaceutical and other industries
- or internal wiping of processing tools and other equipment

[RoHS Report](#)
[Halogen Report](#)
[Silicone oil test report](#)
[Metal Ion Report](#)
  
[Breaking Strength Report](#)
[Cleanliness Report](#)



**Hot Selling**

ISO CLASS 4-5

RoHS

- Dust removal and decontamination
- Economical and durable
- Water and oil absorption

**Polyester heavy-duty Cleanroom wiper**

Model	Specification	Packaging
WH01	140 g/m <sup>2</sup> , hot melt, 6*6 inch	150 pcs/pack
WH02	140g/m <sup>2</sup> , hot melt, 30*30cm	100 pcs/pack
WH03	145g/m <sup>2</sup> , hot melt, 9*9 inch	100 pcs/pack

- Good ability to absorb solvents and resist chemicals, compatible with a variety of solvents
- Good wiping performance, which can save the amount of wiping wiper

**Application scenarios:**

- Mainly used for cleaning equipment and clean room environments in semiconductors, magnetic heads, hard disks, TFT-LCD, machinery, pharmaceutical and other industries
- for internal wiping of processing tools and other equipment

[RoHS Report](#)
[Halogen Report](#)
[Silicone oil test report](#)
[Metal Ion Report](#)
  
[Breaking Strength Report](#)
[Cleanliness Report](#)



**RECOMMENDED**

ISO CLASS 4-5

RoHS

- Low dust generation
- Water and oil absorption
- Dust removal and decontamination

**Microfiber Cleanroom wiper**

Model	Specification	Packaging
WM01	180g/m <sup>2</sup> , laser, 9*9 inch	100 pcs/pack
WM02	195g/m <sup>2</sup> , laser, 9*9 inch	100 pcs/pack
WM03	230g/m <sup>2</sup> , laser, 9*9 inch	100 pcs/pack
WJ01	100g/m <sup>2</sup> , laser, 9*9 inch	100 pcs/pack
WJ02	110g/m <sup>2</sup> , laser, 9*9 inch	100 pcs/pack
WJ03	110g/m <sup>2</sup> , laser, 9*9 inch	100 pcs/pack

- Clean and package in a Class 10 clean room, strictly control dust generation, ion content, NVR
- A variety of edge banding methods can be selected according to needs
- Mainly used in precision instruments, LCD panels, semiconductors, etc.

[RoHS Report](#)
[Halogen Report](#)
[Silicone oil test report](#)
[Metal Ion Report](#)
  
[Breaking Strength Report](#)
[Cleanliness Report](#)



**Hot Selling**

ISO CLASS 4-5

RoHS

- Soft surface
- Low dust generation
- Low NVR

Microfiber fiber hollow citrus petal tissue

Wiping direction

Dirt adsorbed on the rice-shaped skeleton

**Polyester Microfiber Cleanroom wiper**

Model	Specification	Packaging
WF01	110g/m <sup>2</sup> , laser, 9*9 inch	100 pcs/pack
WF02	130g/m <sup>2</sup> , hot melt, 9*9 inch	100 pcs/pack
WF03	170g/m <sup>2</sup> , laser, 9*9 inch	100 pcs/pack

- Cleaning and packaging in a Class 10 clean room, soft fabric, low gram weight, more cost advantages, low ion content, Product testing per IEST method
- A variety of edge banding methods can be selected according to needs

**Application scenarios:**

- Mainly used in precision instruments, liquid crystal panels, semiconductors and other electronic industries, suitable for Class 10 ~ 100,000 clean rooms

[RoHS Report](#)
[Halogen Report](#)
[Silicone oil test report](#)
[Metal Ion Report](#)
  
[Breaking Strength Report](#)
[Cleanliness Report](#)



**RECOMMENDED**

ISO CLASS 4-7

RoHS

- Soft surface
- Low dust generation
- Low NVR

**Polyester heavy-duty high absorbent Cleanroom wiper**

Model	Specification	Packaging
WH04	150g/m <sup>2</sup> , laser, 9*9 inch	100 pcs/pack

- Woven with 100% continuous polyester fiber (polyester filament), good abrasion resistance
- Unique surface fluffy fabric can firmly lock particulate matter on the surface of the wipe
- Product test according to IEST method, clean the package with 18MΩ DI water in Class 10 clean room

**Application scenarios:**

- Mainly used for cleaning clean room environments in semiconductor, magnetic head, hard disk, TFT-LCD, machinery, pharmaceutical and other industries
- suitable for surface wiping of processing tools and other equipment

[RoHS Report](#)
[Halogen Report](#)
[Silicone oil test report](#)
[Metal Ion Report](#)
  
[Breaking Strength Report](#)
[Cleanliness Report](#)



ISO CLASS 4-5

RoHS

Polyester long fiber

- Efficient adsorption
- Low dust generation
- Unique texture

**Anti-static Cleanroom wiper**

Model	Specification	Packaging
WE01	180g/m <sup>2</sup> , laser, 9*9 inch	100 pcs/pack
WE02	120g/m <sup>2</sup> , 48*68cm	25 pcs/pack

- Made of polyester or polyester nylon filament and high-performance conductive yarn, it has a long-lasting anti-static effect, Surface resistance 10<sup>5</sup>-10<sup>10</sup>Ω
- The static dissipation speed is less than 1.5 seconds, which can be adjusted according to the process, and the friction voltage can be less than 100V
- Control anti-static values for each batch to ensure anti-static function
- Cleanliness is tested according to IEST method
- Adjust the width of conductive wire according to customer needs (1cm, 1.5cm, 2cm...)

[RoHS Report](#)
[Halogen Report](#)
[Silicone oil test report](#)
[Metal Ion Report](#)
  
[Breaking Strength Report](#)
[Cleanliness Report](#)



ISO CLASS 4-5

RoHS

Anti-static

- Soft surface
- Low dust generation
- Water and oil absorption

**Lamination polyester Cleanroom wiper**

Model	Specification	Packaging
WD01	240g/m <sup>2</sup> , laser, 9*9 inch	50 pcs/pack

- Made of 100% polyester filament knitted and then ultrasonically double-layer composite embossed
- Highly absorbent, ensuring ultra-low levels of ions and non-volatile substances
- Helps prevent product and cleanroom contamination by reducing fiber and particle release, and resists abrasion in severe environments

**Application scenarios:**

- Designed for critical cleanroom environments such as semiconductor and pharmaceutical manufacturing
- Double-layer fabric composite construction for spill control and general wiping areas where contamination control and absorption are critical

[RoHS Report](#)
[Halogen Report](#)
[Silicone oil test report](#)
[Metal Ion Report](#)
  
[Breaking Strength Report](#)
[Cleanliness Report](#)



ISO CLASS 4-5

RoHS

- Double-layer structure
- Super wear resistance
- Efficient adsorption

**Nano-scale Microfiber Cleanroom wiper**

Model	Specification	Packaging
WG01	150g/m <sup>2</sup> , ultrasonic wide edge banding, 9*9 inch	100 pcs/pack

- Advantages over traditional wiper using a new generation of weaving, automatic inspection, cleaning and handling processes
- The special textile method of polyester/nylon microfiber can improve absorption and remove foreign matter contamination, and the high-density and ultra-smooth properties can reduce the shedding of micron particles, which can eliminate the shedding of particles of specific sizes when used for heavy equipment cleaning
- Non-stretchable fabric with ultrasonic sealed edges will not crack during use, eliminating the source of particles; Asymmetric microfiber structure for rapid removal of recalcitrant contaminants with water alone, reducing IPA residual risk
- Effectively control 0.3μm particles, use double-layer clean bag vacuum packaging, and avoid contamination before entering the clean room
- Mainly used in wafer fabs operating below 10nm nodes in ISO 4-5 clean room environments of semiconductor FAB factories

[RoHS Report](#)
[Halogen Report](#)
[Silicone oil test report](#)
[Metal Ion Report](#)
  
[Breaking Strength Report](#)
[Cleanliness Report](#)



**New products in e industry**

ISO CLASS 4-5

RoHS

- Unique texture
- Super wear resistance
- Low dust generation

- 02 Human protection
  - 03 Electrostatic control
  - 04 Environmental purification
- Secondary category
- A Cleanroom wiper
  - B Cleanroom nonwoven wiper
  - C Cleaning Supplies Aids
  - D Office supplies series
  - E Sticky series
  - F Cotton swab series
  - G Mop + Mopwiper

- 02 Human protection
  - 03 Electrostatic control
  - 04 Environmental purification
- Secondary category
- A Cleanroom wiper
  - B Cleanroom nonwoven wiper
  - C Cleaning Supplies Aids
  - D Office supplies series
  - E Sticky series
  - F Cotton swab series
  - G Mop + Mopwiper

### Island Cleanroom wiper

Model	Specification	Packaging
WI01	200g/m <sup>2</sup> , laser, 4*4 inch	400 pcs/pack

- Sea island wiper fiber has high strength and wear resistance, and can withstand frequent use wear and tear
- Haidao microfiber monofilament has small fineness, large fiber specific surface area, high coverage and adsorption, and good water and oil absorption
- After opening the fibers, the fibers are easy to entangle with each other, forming dense fluff on the surface of the fabric, with uniform surface suede and not easy to peel off

#### Application scenarios:

- Cover plate, lens, ceramic back cover, fitting assembly and other processes

[RoHS Report](#)
[Halogen Report](#)
[Silicone oil test report](#)
[Metal Ion Report](#)
  
[Breaking Strength Report](#)
[Cleanliness Report](#)



**New**

**RoHS**

- Unique texture
- Soft surface
- Low dust generation

### High-density Cleanroom wiper

Model	Specification	Packaging
WI02	230g/m <sup>2</sup> , laser, 6*6 inch	100 pcs/pack

- High-density weaving, tight structure, small gaps between fibers. Extremely fine fibers with large specific surface area
- Efficient absorption of dust, oil, etc., low dust release, avoiding secondary pollution
- Soft and does not damage the surface, high strength, wear-resistant, good water absorption and quick drying, Resistant to common chemicals, no residue after use

#### Application scenarios:

- Mainly used in precision instruments, LCD panels, semiconductors, etc.

[RoHS Report](#)
[Halogen Report](#)
[Silicone oil test report](#)
[Metal Ion Report](#)
  
[Breaking Strength Report](#)
[Cleanliness Report](#)



**RECOMMENDED**

**New**

**RoHS**

- Super wear resistance
- Unique texture
- Low dust generation

### cleanroom pre-wet wiper

Model	Specification	Packaging
WP01	120g/m <sup>2</sup> , 9*9 inch isopropyl alcohol/ultrapure water:70%/30%	20 pcs/pack
WP02	180g/m <sup>2</sup> , 9*9 inch isopropyl alcohol/ultrapure water:70%/30%	50 pcs/pack
WP03	110g/m <sup>2</sup> , 9*9 inch isopropyl alcohol/ultrapure water:70%/30%	20 pcs/pack

- Cleanroom wiper and cleanroom nonwoven wiper are pre-wetted with precisely configured IPA or ethanol/deionized aqueous solution to enhance decontamination control capabilities
- Has bactericidal effect, the bactericidal efficacy can reach 99.9%, no need to store chemical solutions, no need to recycle processing
- Reduce potential safety hazards of flammable products, avoid dipping solutions on site, save time and costs, and reduce secondary pollution caused by solution blending, saving costs

[RoHS Report](#)
[Halogen Report](#)
[Metal Ion Report](#)
[Cleanliness Report](#)
  
[Breaking Strength Report](#)
[Bactericidal efficacy report](#)
[Endotoxin Report](#)



**RoHS**

- Efficient and fast
- Multi-solvent compatibility

### Sterilization 3S cleanroom pre-wet wiper

Model	Sterilize	Specification	Packaging
WS01	Sterilized	Microfiber 195g/m <sup>2</sup> , 9*9 inch, laser	100 pcs/pack
WS02	Sterilized	Polyester 120g/m <sup>2</sup> , 9*9 inch, hot melt	100 pcs/pack
WS03	Sterilized	Imitation Super 110g/m <sup>2</sup> , 9*9 inch, laser	100 pcs/pack
WS04	Sterilized	Polyester composite wiper 240g/m <sup>2</sup> , 9*9 inch, laser	100 pcs/pack

- Sterile medical products must be free of viable microorganisms. According to national standards, unexpected microbial contamination should be minimized before sterilization. According to ISO11137 Standard operations to achieve sterile transformation of products
- Using laser or imported hot wire cutting and cleaning with sterile ultrapure water, it can be made into wet and dry products, and solvent and material combinations can also be customized as needed ;Mainly suitable for Class 10 to Class 10,000 dust-free workshops

[Halogen Report](#)
[Metal Ion Report](#)
[Cleanliness Report](#)
[Sterility Test Report](#)
  
[Breaking Strength Report](#)
[Bactericidal efficacy report](#)
[Endotoxin Report](#)
[Proof of irradiation](#)



**RoHS**

**Irradiation sterilization**

- sterility
- Efficient and fast
- Multi solvent compatibility

### Industrial machine cleaning wiper

Model	Specification
WI01	The fabric has good water absorption, the fabric size is 50 * 60cm, and the tolerance is ± 5 cm

- Instant water absorption, the water absorption capacity can reach 500ml/m<sup>2</sup>, 1.5 times that of ordinary Cleanroom wiper, High cost performance, tight weaving, not easy to shed chips and lint, strong water and oil absorption ability
- No need to cut, it is the first choice for wiping equipment in the automotive industry
- Strong decontamination and wiping ability, clean and hygienic, reduces re-contamination, soft, scratch-free, not easy to damage the surface

#### Application scenarios:

- Mechanical wiping, compact devices, electronic equipment, automobile maintenance, electric fields, mining plants, printing plants and other industries that require mechanical wiping



**RoHS**

- Dust removal and decontamination
- Economical and durable
- Water and oil absorption

### Metallic wiper

Model	Specification	Packaging
WZ01	Steel flannel wiper, wiper width * wiper length: 50mm * 50m, thickness: 0.6 mm	1 roll/pack

- The metal wiper is made of 316L stainless steel fiber, with a fiber diameter between 8-12 microns, which has high strength, corrosion resistance, high temperature resistance and other characteristics
- wiper made of stainless steel fiber has excellent abrasion resistance and is suitable for glass cleaning with frequent wiping
- The fine fiber diameter helps the metal wiper show better performance in many aspects, such as electrical conductivity, thermal conductivity, filtration efficiency, etc.

#### Application scenarios:

- Wipe the phone glass

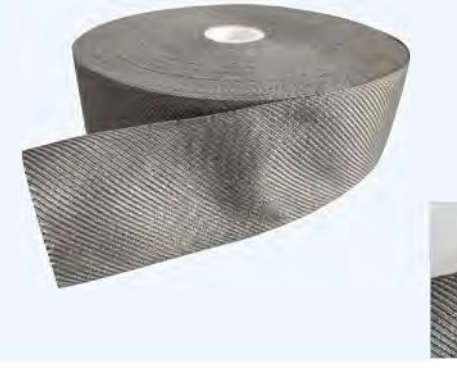

**RoHS**

**New**

- High temperature resistance
- Corrosion resistance
- Abrasion resistance

### Nano polishing wiper

Model	Specification	Packaging
WR01	wiper width * wiper length: 75cm * 50m, coil core: inner diameter: φ26 * L750mm	1 roll/pack

- Small fiber diameter (close to 5 microns), uniform suede surface, can remove oil and fine dust without damaging the surface of the wipe
- Unique cutting and overlocking technology, does not generate static electricity, is not easy to peel off, and can remove materials that are not easy to clean with ordinary Cleanroom wipers
- This cleaning product has excellent performance, thin and soft fibers, which can protect items from damage during cleaning

#### Application scenarios:

- Can easily wipe off hard-to-remove oil stains and fingerprints on glass and metal surfaces

[RoHS Report](#)
[Halogen Report](#)
[Metal Ion Report](#)
[Breaking Strength Report](#)
  
[Cleanliness Report](#)



**Hot Selling**

**RoHS**

New products in the industry

- Precision polishing
- Efficient and fast
- Multi-solvent compatibility

### High-density wiper roll

Model	Specification	Packaging
WR02	40mm*20m,inner diameter * length :φ27mm*40mm	1 roll/pack
WR03	15mm*25m,inner diameter * length :φ34mm*L15mm	1 roll/pack
WR04	18mm*25m,inner diameter * length :φ33mm*L18mm	1 roll/pack
WR05	10mm*30m,inner diameter * length :φ27mm*L10mm	1 roll/pack
WR06	20mm*15m,inner diameter * length :φ26mm*L20mm	1 roll/pack

- Made of polyester and nylon blended yarn woven with microfiber, with patented edge sealing technology at the edges, which has good wear resistance
- Compact structure, can easily remove oily and water-based residues and fine dust on the surface

#### Application scenarios:

- Mainly used in the cleaning process of automatic production lines, in environments ranging from Class 10 to Class 100,000

[RoHS Report](#)
[Halogen Report](#)
[Breaking Strength Report](#)
[Cleanliness Report](#)

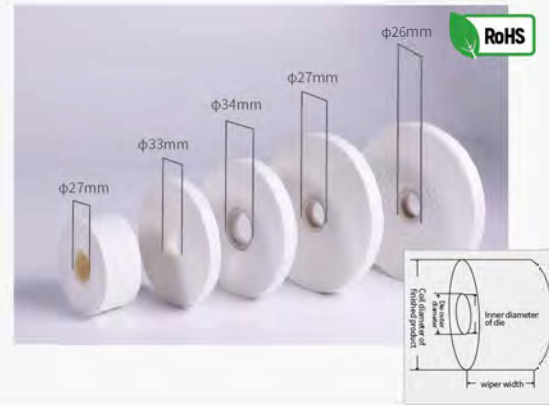

### Island fiber wiper roll

Model	Specification	Packaging
WR07	20mm*17m,inner diameter * length:φ32*φ25.5*L20mm	1 roll/pack

- Sea island wiper fiber has high strength and wear resistance, and can withstand frequent use wear and tear
- Haidao microfiber monofilament has small fineness, large fiber specific surface area, high coverage and adsorption, and good water and oil absorption
- This cleaning product has excellent performance, thin and soft fibers, which can protect items from damage during cleaning
- After opening the fibers, the fibers are easy to entangle with each other, forming dense fluff on the surface of the fabric, with uniform surface suede and not easy to peel off

#### Application scenarios:

- Cover plate, lens, ceramic back cover, fitting assembly and other processes

[RoHS Report](#)
[Halogen Report](#)
[Breaking Strength Report](#)
[Cleanliness Report](#)



### Microfiber wiper roll

Model	Specification	Packaging
WR08	18mm*25m,inner diameter * length:φ33mm*L18mm	1 roll/pack
WR09	20mm*100m,inner diameter * length:φ25*L20mm	1 roll/pack

- Made of a blend of polyester and nylon, woven with microfiber, with patented edge sealing technology at the edges
- Compact construction to easily remove oily and waterbased residues and fine dust on surfaces
- The advantage of the product is that it saves solvent consumption, produces fewer volatile pollutants, has excellent chemical tolerance, and is compatible with a variety of solvents • Can provide product samples of different sizes and models, and the size specifications can be customized according to requirements

#### Application scenarios:

- Mainly used in the cleaning process of automatic production lines, in environments ranging from Class 10 to Class 100,000

[RoHS Report](#)
[Halogen Report](#)
[Breaking Strength Report](#)
[Cleanliness Report](#)



### Nano Polished wiper roll

Model	Specification	Packaging
WR10	65cm*50m,core: inner diameter:φ76*L650mm,thickness:0.5±0.05mm	1 roll/pack

- Small fiber diameter (close to 5 microns), uniform suede surface, can remove oil and fine dust without damaging the surface of the wipe
- Unique cutting and overlocking technology, does not generate static electricity, is not easy to peel off, and can remove materials that are not easy to clean with ordinary Cleanroom wipers
- This cleaning product has excellent performance, thin and soft fibers, which can protect items from damage during cleaning
- Good ability to absorb solvents and resist chemicals, compatible with a variety of solvents

#### Application scenarios:

- Can easily wipe off hard-to-remove oil stains and fingerprints on glass and metal surfaces

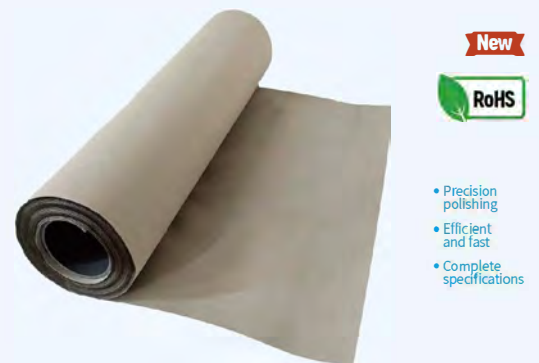

### cleanroom nonwoven wiper: unique non-woven fabric structure, all-round wiping choice

cleanroom nonwoven wiper adopts a unique non-woven fabric structure, which has extremely high durability and strong water absorption. Its surface textures are diverse, which can meet the wiping needs of various scenarios, whether it absorbs water or oil. Moreover, it has high strength in both wet and dry conditions, which is enough for daily wiping.

#### • Texture of cleanroom nonwoven wiper ( the following textures can be made optionally)



#### • Packaging classification of cleanroom nonwoven wiper

Slice	Disconnected point extraction	1/2 fold	1/4 fold	Coreless roll	Big roll	Extractable	Printing wiper roll	Printing and wiping large roll	Folding box

### MBPP cleanroom nonwoven wiper

Model	Specification	Packaging
WN01	80g/m <sup>2</sup> ,12*12inch	100 pcs/pack

- Made of meltblown polypropylene, it can quickly absorb oil stains 6 times its own weight, and can wipe oil stains, water and various solvents
- The material is firm and has strong wet strength, and can be used with solvents to treat the surface of objects
- Can be used for maintenance of machine tools and large equipment, as well as removing various ink leaks

#### Application scenarios:

- Suitable for wiping oil stains during machinery and equipment, assembly and maintenance, and cleaning and wiping printing rollers and equipment
- Used for related wiping work in automobile maintenance factories and oil shops, as well as wiping before automobile painting and finished product painting
- It can also be used to wipe screen ink, clean and maintain clips and fixtures

[RoHS Report](#)
[Halogen Report](#)
[Breaking Strength Report](#)
[Cleanliness Report](#)



### Highly soft wipe cleaning paper

Model	Specification	Packaging
WN02	Spunlace non-woven fabric 50g/m <sup>2</sup> (viscose + polyester), 340 * 610mm	50pcs/pack

- Highly soft wipe cleaning paper made of 55% polyester and 45% viscose, which is highly absorbent and can quickly absorb moisture
- Low lint removal, not easy to fluff, dander shedding, solvent resistant, heat resistant, wet and dry use

#### Application scenarios:

- Laboratories, laboratories, factories (precision parts), clean rooms, semiconductors, optics (lenses and glass)
- Pharmaceuticals (pharmaceuticals and cosmetics), food processing, printing (integrated circuit board), liquid crystal, magnetic tape, optical disc, atomic energy
- Absorption of water, solvents, oil, cleaning of mechanical devices, cleaning of tools, cleaning of precision machinery, cleaning of glassware

[RoHS Report](#)
[Breaking Strength Report](#)



### Full cross cleanroom nonwoven wiper

Model	Specification	Packaging
WN03	68 g/m <sup>2</sup> , 9" * 9 inch, full cross nonwoven	300pcs/pack

- Full cross cleanroom nonwoven wiper is made of virgin wood pulp and polyester through spunlace process
- With unique fiber laying technology, 1: 1 distribution of longitudinal and transverse strength
- Strong and not easy to deform, its tensile strength and breaking strength exceed ordinary cleanroom nonwoven wiper, has high solubility resistance, and can be used with various solvents
- Punctured by high-pressure water flow, the cleanroom nonwoven wiper fibers are tight, no lint and dust, and the wipersurface is fine, which can save wiping time and improve efficiency

#### Application scenarios:

Mainly used for wall covering base materials, high-end protective materials, high-end precision instrument wiping, aerospace wiping, etc.

[RoHS Report](#)
[Halogen Report](#)
[Breaking Strength Report](#)
[Cleanliness Report](#)



**RECOMMENDED**  
**RoHS**  
 Non-woven fabric  
 • Dust removal and decontamination  
 • Economical and durable  
 • Water and oil absorption

### M-3 folded cleanroom nonwoven wiper

Model	Specification	Packaging
WN08	35g/m <sup>2</sup> , 25x25cm	100pcs/pack

- M-3 cleanroom nonwoven wiper is a non-woven fabric product made of 100% high-quality long fiber
- The surface of the product has a porous structure, low dust generation, very little static electricity, excellent heat resistance, ecological and environmental protection
- It is super absorbent and protective, and can efficiently remove oil and dust from the machine
- The product is packaged in half, 8 sides can be wiped, users can directly use it for wiping, providing high cleanliness at an economical price

#### Application scenarios:

• Used in electronic printing, integrated circuit boards, instruments, hardware wiping, etc.

[RoHS Report](#)
[Halogen Report](#)
[Breaking Strength Report](#)
[Cleanliness Report](#)



**ISO CLASS 6-8**  
**RoHS**  
 Non-woven fabric  
 High-quality long fiber

### Microfiber cleanroom nonwoven wiper

Model	Specification	Packaging
WN04	80 g/m <sup>2</sup> , 9" * 9 inch, superfine non-woven fabric	300pcs/pack

- The unique fine denier fiber gives the product a large surface-to-volume ratio, greatly expands the water-absorbing surface area, and has strong water absorption
- Microfiber structure can absorb dust without damaging the screen when wiped
- Strong pressure spunlace fixes the net without flocking, reaching 100 Classes of cleanliness, available in sheet or roll shape

#### Application scenarios:

• Used for cleaning sensitive surfaces such as hard disks and camera lenses, suitable for high-end laboratory instruments and operating table maintenance and environmental cleaning  
 • For making wet wiper and masks, for polishing cars and wiping guns

[RoHS Report](#)
[Halogen Report](#)
[Breaking Strength Report](#)
[Cleanliness Report](#)



**New**  
**RoHS**  
 Non-woven fabric  
 • Dust removal and decontamination  
 • Soft surface  
 • Low dust generation

### Wavy cleanroom nonwoven wiper

Model	Specification	Packaging
WN09	White DB pattern, spunlace non-woven fabric 60g, 25 * 35cm, single piece 1/4 folded	300pcs/pack

- 55% polyester/45% wood pulp, can be used with solvent liquids
- High tear resistance and wear resistance, no chips, can be used repeatedly
- Soft texture, not easy to damage the surface
- Good environmental protection, can be recycled and reduced pollution

#### Application scenarios:

• Oil cleaning of equipment in the auto parts industry, chemical industry and other equipment, wiping and maintenance of machinery and printing equipment, wiping and maintenance of experimental equipment

[RoHS Report](#)
[Halogen Report](#)
[Breaking Strength Report](#)
[Cleanliness Report](#)



**Hot Selling**  
 Hot sales in the semiconductor industry  
**New**  
**RoHS**  
 • Unique texture  
 • Dust removal and decontamination  
 • Water and oil absorption

### cleanroom nonwoven wiper

Model	Specification	Texture	Packaging
WN05	Non-woven fabric, 56g/m <sup>2</sup> , 9" * 9 inch	plain weave	300pcs/pack
WN06	Non-woven fabric, 68g/m <sup>2</sup> , 9" * 9 inch	plain weave	300pcs/pack

- Sheet cleanroom nonwoven wiper is made of a waterwrapped non-woven blend of 55% wood pulp and 45% polyester
- Combines high absorbent properties and cleaning strength of natural fiber wiper
- Adopts tight water-wrapped structure, has good biaxial tension and breaking strength, and low chip drop rate
- Using unique wood pulp/polyester mixture material, it has extremely high durability and high water absorption, and the size and texture can be customized according to requirements

#### Application scenarios:

• Mainly used for integrated circuits, printed circuit boards and electronic component manufacturing equipment, cleaning and polishing precision components

[RoHS Report](#)
[Breaking Strength Report](#)



**RoHS**  
 Non-woven fabric  
 • Economical and durable  
 • Water and oil absorption  
 • Dust removal and decontamination

### Sterilization disinfectant wipe (bags, barrels)

Model	Sterilize	Specification	Packaging
WP04	Sterilized	56g/m <sup>2</sup> , 9" * 9 inch	40pcs/pack
WP05	Sterilized	56g/m <sup>2</sup> , 20" * 20cm	40pcs/pack
WP06	Sterilized	PI99-100-75%	100pcs/pack

- Use pharmacopoeia grade (USP) alcohol and 18MQ ultrapure water to ensure the continuous effectiveness and high stability of the disinfectant solution, using cleanroom and clean materials
- The disinfection solution is filled and proportioned through automated equipment, and the finished product is irradiated and sterilized to control the number of microorganisms and pollutant particles at a low Class, thus avoiding cross-contamination in the hospital space and surface. Can adopt any ratio of isopropyl alcohol or ethanol or quaternary ammonium salt, and can be customized
- Mainly used for wiping surfaces of hospital departments, ward office areas, medical equipment

[RoHS Report](#)
[Halogen Report](#)
[Bactericidal efficacy report](#)
[Endotoxin Report](#)

[Sterility Test Report](#)
[Proof of Irradiation](#)



**RECOMMENDED**  
**RoHS**  
 Irradiation sterilization

### Wavy folded cleanroom nonwoven wiper

Model	Specification
WN07	White DB pattern, spunlace non-woven fabric 60g/m <sup>2</sup> , 25x35cm, single piece 1/4 folded

- Wavy folded cleanroom nonwoven wiper made of wood pulp and polyester fiber spunlaced
- Unique wavy structure, three-dimensional concave and convex, good stain wrapping, can accelerate liquid absorption and enhance wiping power
- Folding in half design fits the shape of your hand, making it easy to access, no need to fold manually
- Tear resistance, efficient cleaning, and edge sealing method can be selected as needed

#### Application scenarios:

• It can be used for wiping machinery and equipment and cleaning during assembly and maintenance, wiping printing rollers and related equipment, automobile maintenance, Wipe before painting and finished product coating, and wipe screen ink

[RoHS Report](#)
[Breaking Strength Report](#)



**RoHS**  
 Non-woven fabric  
 • Unique texture  
 • Water and oil absorption  
 • Dust removal and decontamination

### Cleanroom pre-wet paper

Model	Specification	Packaging
WP07	35 g/m <sup>2</sup> , 9" * 11 inch, ethanol/ultrapure water: 75%/25%	30pcs/pack
WP08	56 g/m <sup>2</sup> , 20" * 20 cm, ethanol/ultrapure water: 75%/25%	40 pcs/pack, 25 packs/box

- MBPP meltblown material is preferred, which is compact and tough, not easy to break
- The fiber diameter reaches 1-5 microns, the material has many voids, fluffy structure, and good wrinkle resistance
- The process is produced by a continuous one-step process of high-temperature melting, spinning, screen laying, and hot pressing and coiling

#### Application scenarios:

• Widely used in public places, schools and homes to disinfect surfaces of various objects  
 • Suitable for hospitals and other institutions and multiple industries, used for surface cleaning and disinfection of machinery, environment, and supplies and residue removal

[RoHS Report](#)
[Halogen Report](#)
[Bactericidal efficacy report](#)
[Endotoxin Report](#)



**RoHS**  
 • Efficient and fast  
 • Multi-solvent compatibility

02 Human protection

03 Electrostatic control

04 Environmental purification

Secondary category

A Cleanroom wiper

B Cleanroom nonwoven wiper

C Cleaning Supplies Aids

D Office supplies series

E Sticky series

F Cotton swab series

G Mop • Mopwiper

02 Human protection

03 Electrostatic control

04 Environmental purification

Secondary category

A Cleanroom wiper

B Cleanroom nonwoven wiper

C Cleaning Supplies Aids

D Office supplies series

E Sticky series

F Cotton swab series

G Mop • Mopwiper

### Cleanroom lens cleaning paper

Model	Specification	Packaging
WN10	MN-2, low dust wipe paper, 100% wood pulp, length * width 11 * 20cm	280 pcs/box

- The product uses virgin wood pulp and is equipped with special processing technology, which produces low dust and can save a lot of wiping time
- The paper is fine and will not scratch the surface of the quilt
- Good wet and dry strength, not easy to break
- Pure texture, efficient water absorption

#### Application scenarios:

- Wipe and clean precision instruments such as optical lenses

RoHS Report Halogen Report Breaking Strength Report



Import replacement

New



- Unique texture
- Dust removal and decontamination
- Water and oil absorption

### Sulfur-free paper

Model	Specification	Packaging
WN11	Length * width 184 * 184mm (tolerance ± 1 mm), sulfur content < 50mg/kg	500 pcs/box

- Made of pure wood pulp, the paper has good toughness and is not easy to wear
- Flat, smooth, uniform density, no holes, no spots
- Effectively avoid chemical reactions between silver in electroplated products and sulfur in the air, prevent products from turning yellow, and protect product quality and appearance

#### Application scenarios:

- It is mainly used for packaging and transportation of silver-plated products, such as circuit board, LED, circuit board, hardware terminal, etc

RoHS Report Halogen Report Breaking Strength Report



Hot Selling

Hot sales in the semiconductor industry

New

### Dust Free Spacer Paper (ESD)

Model	Specification	Packaging
WN12	Round cleanroom spacer paper, 5 inches in diameter	200 pcs/box

- Made of high-density polyethylene filaments processed by special technology, strong and durable texture
- Flat, smooth, uniform density, no holes, no spots, surface resistance:  $10^7-10^{10}$
- Waterproof and PH neutral, chemically inert, capable of maintaining excellent performance in a variety of environmental conditions

#### Application scenarios:

- Suitable for integrated circuits, precision electronics, silicon wafer manufacturing, solar cells and other industries

RoHS Report Breaking Strength Report Cleanliness Report



Import replacement in semiconductor industry

New



Anti-static

- Low dust generation
- Strong and durable

### Wafer gasket paper (ESD)

Model	Specification	Packaging
WN13	Black, plain weave, 8 "dia	200 pcs/box

- Wafer gasket paper (ESD) is tailored for wafer protection
- Excellent anti-static function, instantly removing charge; Strictly control particle formation to ensure cleanliness, Exquisite single or double-sided embossing process to provide solid support
- It has excellent cushioning and shock resistance, firmly protects wafers during transportation and storage, and builds a solid foundation for safety in chip manufacturing

#### Application scenarios:

- A range of electrostatic protection packages for memory, CMOS, IC semiconductor wafers and electronic devices

RoHS Report Breaking Strength Report Cleanliness Report



New



Anti-static

### SMT nonwoven wiper roll

Steel mesh wipe paper is made of 55% virgin wood pulp and 45% polyester filament, combining the high absorbency of natural fibers with the high absorbency of synthetic materials clarity and intensity are integrated. Used to help transfer a certain amount of solder paste to the corresponding position of the PCB. Usually online printing 3-5 pieces, The steel mesh needs to be cleaned with wiping paper. The steel mesh wiping paper is used for daily maintenance to clean the solder paste residue on the steel mesh to prevent contamination and ensure printing quality.

- Antiacid, resistant to most chemicals
- Low dust, low ion residue, good wiping effect, high water storage capacity
- Can effectively control the amount of static electricity generated and can be used multiple times
- Strong hygroscopicity, strong cleaning function, soft, wear-resistant and corrosion-resistant
- Can provide sample processing of products of different sizes and models, and the size specifications can be customized according to requirements

#### Application scenarios:

- Mainly used for cleaning and maintenance of fully automatic solder paste printing machines, power battery and electrode cleaning, etc.

RoHS Report Halogen Report Breaking Strength Report Cleanliness Report



Size can be customized

- Water and oil absorption
- No dander shedding
- Efficient decontamination

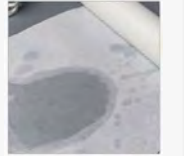

CoCorresponding printing machine	Model	Specification mm (tube length * paper width * paper length)	Inner diameter	Tube	Open mouth	Packaging	
GKG	G001	530*400*10	Inner diameter 20	Rubber hose	Open at both ends	1 Roll/Pack 50 Packs/Carton	
	G002	530*380*10			Cross opening at both ends (opening width 3.06 mm)		
	G003	530*500*15			Straight bayonet at both ends		
EKRA SERIO4000	G004	500*380*10	Inner diameter 13.5		Straight bayonet at both ends, slot: 3 * 6mm		
DEK The pipe length is 530mm, which has a high market share	G005	530*520*10	Inner diameter 20		Rubber hose		Straight bayonet at both ends, slot: 3 * 6mm
	G006	530*500*10					
	G007	530*500*10					
	G008	530*450*10					
	G009	530*400*10					
	G010	530*350*10					
	G011	530*350*10					
	G012	530*300*10					
	G013	530*280*10					
	G014	530*240*10					
MPM The length of the pipe is 455, and there are 12 convex grooves built in at both ends	G015	455*450*10	Inner diameter 19.5	Paper tube	One-word opening at both ends, built-in 12 convex grooves		
	G016	455*380*10					
	G017	455*300*10					
	G018	455*300*10					
Desen	G019	410*300*10	Inner diameter 20		Straight bayonet at both ends		
MINAMI	G020	290*270*10	Inner diameter 8		Paper tube	Straight bayonet at both ends, groove depth/groove width: 6 * 3mm	
	G021	290*240*10					
Hitachi	G022	360*350*10	Inner diameter 25			Flat opening at both ends	
Panasonic	G023	480*450*10	Inner diameter 38			Straight bayonet at both ends	

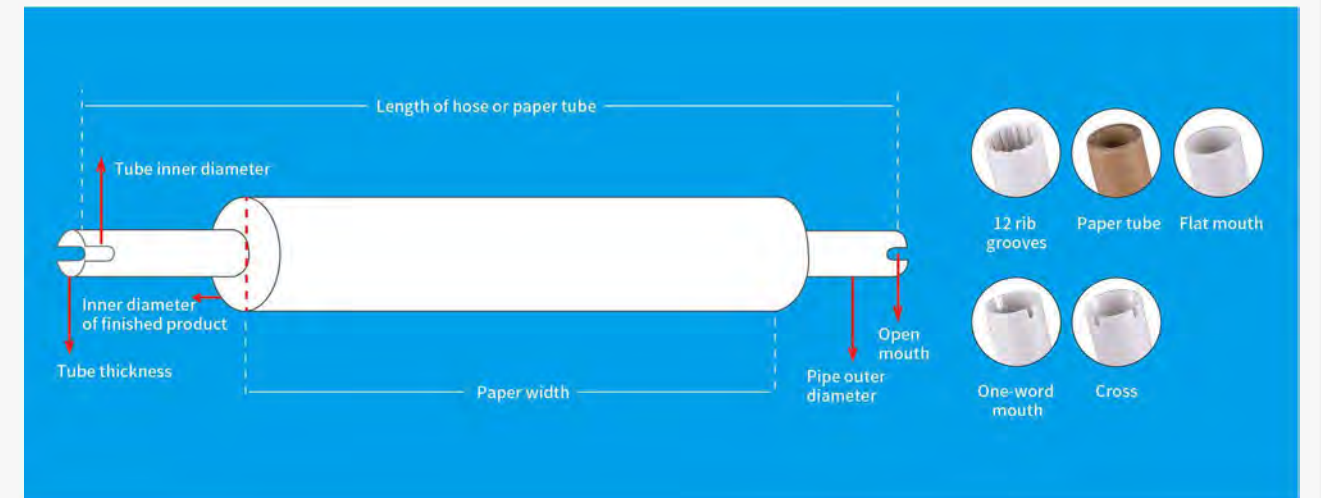

- 02 Human protection
  - 03 Electrostatic control
  - 04 Environmental purification
- Secondary category
- A Cleanroom wiper
  - B Cleanroom nonwoven wiper
  - C Cleaning Supplies Aids
  - D Office supplies series
  - E Sticky series
  - F Cotton swab series
  - G Mop - Mop wiper

- 02 Human protection
  - 03 Electrostatic control
  - 04 Environmental purification
- Secondary category
- A Cleanroom wiper
  - B Cleanroom nonwoven wiper
  - C Cleaning Supplies Aids
  - D Office supplies series
  - E Sticky series
  - F Cotton swab series
  - G Mop - Mop wiper

### Machine wipe paper

Model	Specification	Packaging
NR01	1610mm*φ47mm*φ55mm,56g	2 rolls/box
NR02	1520mm*1440mm*100m, 56g	2 rolls/box

- Wood pulp/polyester double-layer structure, strong and durable, with efficient water and oil absorption
- Strong longitudinal and horizontal strength, tensile resistance, excellent pollution removal ability and no residual dust
- The surface of the tab is clean during the manufacturing process of the lithium battery factory, has a good function of removing electrolyte crystals, and has strong liquid absorption

#### Application scenarios:

- Suitable for powder cleaning in automated manufacturing processes of lithium-ion batteries

RoHS Report    Halogen Report



### Nonwoven wiper roll

Model	Specification	Packaging
NR03	Wood pulp + polyester, 25*37cm	500 pcs/roll
NR04	Wood pulp + polyester, 25*37cm	500 pcs/roll
NR05	PP+wood pulp, embossed, 31.8*34cm	500 pcs/roll

- High absorption performance, 60% and 75% higher water and oil absorption than traditional wiping products, respectively; High strength in wet and dry conditions to meet daily wiping needs, and does not contain heavy metals or pathogenic germs
- Extremely low chip fall and leaves no dust after wiping, meets the requirements of the process environment, does not fade, does not contain silicone resin, ensures process safety

#### Application scenarios:

- Mainly used to wipe the surface parts of high-end precision products and equipment
- Mainly used to remove residues of lubricants and adhesives, and can also be used as a solution to remove disinfectants

RoHS Report    Halogen Report



### Roll Dispenser

Model	Specification	Packaging
FS	Width * length * depth: 380 * 1090 * 700mm	1 pc/box

- High-quality material, stable structure, easy to move, suitable for large rolls of different sizes, universal and portable
- Ability to easily peel off wiper for easy refill replacement

#### Application scenarios:

- Special paper holder for industrial wiper, suitable for electronic industry, precision machinery, clean room, cleanroom workshop and other industries

RoHS Report    Halogen Report



### Pressure-sensitive paper

Model	Specification	Packaging
WY01	LW:270mm*10m; Low voltage double-piece 2.5-10Mpa	2 rolls/box
WY02	LLW:270 mm*6 m; Ultra-low voltage double-chip type 0.5-2.5 Mpa	2 rolls/box
WY03	LLLLLW:310 mm* 3 m; Micro-pressure double sheet type 0.05-0.2 Mpa	2 rolls/box
WY04	LLLLLW:270 mm* 5 m; Ultra-ultra-low voltage double-chip type 0.2-0.6 Mpa	2 rolls/box

- Pressure-sensitive paper, also known as pressure test film and pressure test film, is a balance, distribution and size, flatness of product joints, sealability, when pressure is applied, the color changes to red, and the color density depends on it, it is convenient and intuitive to check the distribution and uniformity of the applied pressure, fast measurement speed, clear and intuitive image after pressing
- Different color densities, corresponding to the applied pressure, the pressure value can be measured through the standard pressure density curve

RoHS Report    Halogen Report



### Cleanroom pen

Model	Specification	Packaging
WB01	American Sharpie, Model, 32001, Red	12 pcs/box 144 pcs/carton

- The cleanroom pen has a simple design and is easy to use. The shaft is square and designed with a pen grip pattern. Users can hold the pen firmly even when wearing gloves
- The cleanroom pen uses low ion content ink, which effectively reduces its pollution to the clean room. Can be written on optical disc, metal, glass, plastic and acrylic and other surfaces of any items, waterproof and odorless
- Oil-based ink, waterproof, not easy to fade, double tip, one end thick and the other end thin, large capacity ink and fine sealing performance, extend service life

#### Application scenarios:

- Mainly used for surface marking of biological laboratory glassware, test tubes, etc. It is not easy to fade in low temperature environment
- Can be DIY hand-painted on ceramics, cards and other surfaces, multi-purpose, AP certified, environmentally friendly, used for industrial marking such as laboratories and clean rooms



### Cleanroom notebook

Model	Specification	Packaging
WB02	A1, A5, regular nailed	50 pages, spiral package
WB03	A1, A5, regular nailed	50 pages, spiral package
WB04	A1, A5, regular nailed	50 pages, spiral package

- Bound with professional purified paper, significantly reduces the generation of fine dust and enhances the ink absorption capacity
- Can minimize the generation of fine dust from the binding hole of the binding purified notebook
- Provide purification notebooks and notebooks in various sizes and colors
- Low dust generation: extremely low dust generation (less than 1/1000 lower than ordinary paper)
- Note-taking: Both oil-based and water-based pens can be used
- Dimensional stability: Small dimensional changes affected by temperature and humidity

RoHS Report



### Cleanroom printing paper

Model	Specification	Packaging
WZ01	A4, pink	80g, 250 sheets/pack
WZ02	A4, pink	72g, 250 sheets/pack
WZ03	A5, white	72g, 250 sheets/pack
WZ04	A3, white	80g, 250 sheets/pack
WZ05	A3, yellow	80g, 250 sheets/pack

- cleanroom printing paper is special paper for operating rooms, laboratories, and clean rooms, used for copying, printing (ordinary printing, format printing), writing records, and inserting paper jams in processes
- Can be decomposed in water, can be recycled, and has low ion content, good tear resistance, smooth surface, good writing effect and printing effect, uniform thickness, consistent density and low dust emission, can be made according to customer requirements Different specifications



### Antibacterial sticky mat

Model	Specification	Packaging
M01	18*45, 4.0C	Regular 10 books/box, 5 boxes/box

- Contains antibacterial ingredients to inhibit the growth and reproduction of various microorganisms and reduce cross-infection
- The surface is highly viscous and can absorb tiny impurities such as dust and hair
- Multi-layer structure, if the upper layer is dirty, just tear off the film, and the lower layer can continue to absorb dust

#### Application scenarios:

- Industrial production, medical and health, scientific research and experiment, commercial office and public service, family life

RoHS Report

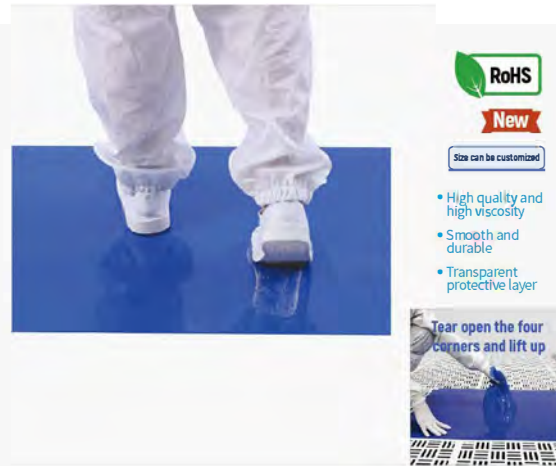

RoHS

New

Size can be customized

- High quality and high viscosity
- Smooth and durable
- Transparent protective layer



Tear open the four corners and lift up

### Open-pore sticky mat

Model	Specification	Packaging
M02	Medium viscous, 3C, 1935 * 1655mm	30 pages/book, 10 books/box TY

- Used in the air shower room, the mold is opened and cut according to the size of the air shower port. The unique opening design increases the contact area with dust and can quickly absorb all kinds of fine dust, hair and debris, significantly improving the cleaning effect
- The porous structure enhances air circulation, reduces viscosity and resistance when people or objects pass by, and makes walking smoother
- The opening does not affect its viscous delamination characteristics, and it can be easily peeled layer by layer after use, making it convenient and quick to deal with adsorbed dirt and maintaining good dust adhesion performance
- After the upper layer is dirty, the lower layer continues to stick to dust, extending the service life

- Suitable for customized equipment, air showers, etc.

RoHS Report

Anti-static report



Hot Selling

Size can be customized

RoHS

Anti-static

New

- High quality and high viscosity
- Environmentally friendly and
- Not easy to degumming

With continuous numbering, the number of remaining sheets can be known by numbering

### Washable Silicone Sticky mat

Model	Specification	Packaging
M03	120 * 90cm, thickness 5mm	Determined according to the order quantity

- The material is soft and elastic, comfortable to the touch, and can adapt to the pedaling of different soles, permanently sticky, it can efficiently capture dust, hair and other contaminants on the soles to keep the floor clean
- Washable and reusable, economical and environmentally friendly, feasible for people or vehicles to pass through, especially suitable for places where people come and go and people often step on

#### Application scenarios:

- Light wheel cleaning, wheel cleaning, semi-automatic and human forklifts, cargo shower channels, air shower indoor barrier entrances

RoHS Report

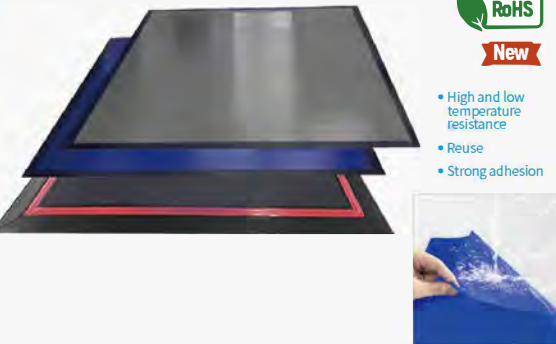

Size can be customized

RoHS

New

- High and low temperature resistance
- Reuse
- Strong adhesion

### Patterned sticky mat (home)

Model	Specification	Packaging
M04	60*80cm	10 books per box, box gauge, 61*81*15mm

- Unique pattern design adds home decoration, and effectively prevents slip when walking to ensure safety
- Excellent surface stickiness, easily stick to dust, hair, etc. on soles, keeping the room clean
- The multi-layer structure facilitates tearing off the dirty layer layer by layer, quickly renewing, and continuously exert the dust adhesive effect

#### Application scenarios:

- Suitable for homes, hotels and other service places

RoHS Report



Size can be customized

RoHS

New

- High quality and high viscosity
- Smooth and durable
- Not easy to degumming

### Sticky paper

Model	Specification	Packaging
M05	A4	30 copies/box

- The dust sticking paper is designed to remove dust from the manual dust sticking roller. It is the right hand man for the recycling of silicone wheels to ensure its continuous good dust sticking performance
- The polymeric molecules of the surface glue are distributed in high density and have strong adsorption force. Even extremely fine dust particles on the silicone wheel can be quickly and effectively removed
- Its efficient cleaning features not only extend the service life of the silicone wheel, but also improve the efficiency of cleaning work

#### Application scenarios:

- PCB board industry, LCD industry, semiconductor industry, food industry, steel plate, glass processing industry and other industries

RoHS Report



RoHS

New

- High quality and high viscosity
- Smooth and durable
- High efficiency cleaning

### PE adhesive roller

Model	Specification	Packaging
M07	6 inches, 18m/roll	10 rolls/package, 100 rolls/carton

- PE material is moderately viscous and stable, can quickly capture tiny dust, and has a remarkable cleaning effect

#### Application scenarios:

- Dust-adhesive roller is an efficient dust removal tool, widely used in cleaning treatments on a variety of surfaces and industries
- It is especially suitable for surface cleaning in clean rooms, circuit boards, PCBs, LCDs, light guides, electronic semiconductors, and flexible film precision printing
- Dust-sticking rollers are also commonly used to clean glass panels, laminated steel plates, workbenches and other flat surfaces

RoHS Report



RoHS

New

- High quality and high viscosity
- Environmentally friendly and
- Save time and effort

### Machine silicone roller

Model	Specification
M06	Φ70 * 200mm, dark blue slightly sticky, shaft length 268mm, equipped with M6 screws (glue)

- PE material is moderately viscous and stable, can quickly capture tiny dust, and has a remarkable cleaning effect

#### Application scenarios:

- Dust-adhesive roller is an efficient dust removal tool, widely used in cleaning treatments on a variety of surfaces and industries
- It is especially suitable for surface cleaning in clean rooms, circuit boards, PCBs, LCDs, light guides, electronic semiconductors, and flexible film precision printing
- Duststicking rollers are also commonly used to clean glass panels, laminated steel plates, workbenches and other flat surfaces

RoHS Report



RoHS

New

- Smooth rubber surface
- Strong dust adhesion
- High efficiency cleaning

### Silicone roller

Model	Specification
M08	Black handle 10 "
M09	Black handle 8 "
M10	Wide handle 10 "
M11	Wide handle 16"
M12	Wide handle 4"
M13	Wide handle 8"

#### Application scenarios:

- Mainly used in the production of circuit boards, PCBs, LCD processes, light guides, film precision printing, SMT, clean rooms, electronic semiconductors and other industries
- Product time, surface treatment required cleaning tools, also suitable for plastic coating, corona treatment, rubber and plastic machinery rollers

RoHS Report



RoHS

02 Human protection

03 Electrostatic control

04 Environmental purification

Secondary category

A Cleanroom wiper

B Cleanroom nonwoven wiper

C Cleaning Supplies Aids

D Office supplies series

E Sticky series

F Cotton swab series

G Mop • Mop wiper

02 Human protection

03 Electrostatic control

04 Environmental purification

Secondary category

A Cleanroom wiper

B Cleanroom nonwoven wiper

C Cleaning Supplies Aids

D Office supplies series

E Sticky series

F Cotton swab series

G Mop • Mop wiper

Cleanroom swab

This product has good adsorption and viscosity, and is mainly used to clean fine dust particles and stubborn stains on the surface of the exposed SENSOR coating in the COB process. It does not produce dust spots compared to regular cotton swabs (use clean water to wipe the CSPSENSOR surface glass). The product will not scratch SENSOR or leave stains, which can greatly improve the yield of the product. It can remove particles (PARTICLE) on the surface of LED/LCD, and clean debris and powder on the surface glass of LENS in a clean room environment of class 10-1000. It adopts special glue formula, which has permanent adhesiveness, non-volatilization and non-drawing. It has a good protective effect on the electrical performance and appearance of the product and can withstand temperatures below 40°C.



ISO CLASS 3-8  
RoHS  
Heat resistance temperature 40°C below

RoHS Report    Anti-static report    VOC test report

High quality materials    Environmentally friendly and odorless    High efficiency cleaning

Model	Handle Material	Pad color	Viscosity	Packaging	Anti-static	New
MSD-2020-ESD655-0.6 (M)	ABS + glass	Transparent	Medium viscosity	100 pieces/box	Yes	Yes

**Product Features:** Small rubber head, No silicon, no secondary pollution

**Application scenarios:** Small scale dust removal, Handling small products

Handle Dimensions: 70\*Φ1.6    Overall length: 70.5±0.5    Glue width: 0.6±0.1

Model	Handle Material	Pad color	Viscosity	Packaging	Anti-static	New
MSD-2020-ESD655-0.6 (H)	ABS + glass	Black	High viscosity	100 pieces/box	Yes	Yes

**Product Features:** Black rubber head, small rubber head, No silicon, no secondary pollution

**Application scenarios:** Clean fine products

Handle Dimensions: 70\*Φ1.6    Overall length: 70.5±0.5    Glue width: 0.6±0.1

Model	Handle Material	Pad color	Viscosity	Packaging	Anti-static	New
MSD-2020-ESD655-0.8 (L)	ABS + glass	Transparent	Low viscosity	100 pieces/box	Yes	Yes

**Product Features:** Small rubber head, No silicon, no secondary pollution

**Application scenarios:** Small scale dust removal, Handling small products

Handle Dimensions: 70\*Φ1.6    Overall length: 70.5±0.5    Glue width: 0.8±0.2

Model	Handle Material	Pad color	Viscosity	Packaging	Anti-static	New
MSD-2020-ESD655-0.8 (M)	ABS + glass	Transparent	Medium viscosity	100 pieces/box	Yes	Yes

**Product Features:** Small rubber head, No silicon, no secondary pollution

**Application scenarios:** Small scale dust removal, Handling small products

Handle Dimensions: 70\*Φ1.6    Overall length: 70.5±0.5    Glue width: 0.8±0.2

Model	Handle Material	Pad color	Viscosity	Packaging	Anti-static	New
MSD-2020-ESD655-0.8 (M)	ABS + glass	Transparent	Medium viscosity	30 pieces/box	Yes	Yes

**Product Features:** Small rubber head, No silicon, no secondary pollution

**Application scenarios:** Small scale dust removal, Handling small products

Handle Dimensions: 70\*Φ1.6    Overall length: 70.5±0.5    Glue width: 0.8±0.2

Model	Handle Material	Pad color	Viscosity	Packaging	Anti-static	New
MSD-2020-ESD655-0.8 (H)	ABS + glass	Transparent	High viscosity	100 pieces/box	Yes	Yes

**Product Features:** Small rubber head, high viscosity, No silicon, no secondary pollution

**Application scenarios:** Small scale dust removal, Handling small products

Handle Dimensions: 70\*Φ1.6    Overall length: 70.5±0.2    Glue width: 0.8±0.2

Model	Handle Material	Pad color	Viscosity	Packaging	Anti-static	New
MSD-2020-ESD655-1.3 (H)	ABS + glass	Transparent	High viscosity	100 pieces/box	Yes	Yes

**Product Features:** High viscosity and no residual glue, No silicon, no secondary pollution

**Application scenarios:** AOI machine cleaning chip, Clean concave surfaces, blind holes, high gloss surfaces

Handle Dimensions: 70\*Φ1.6    Overall length: 70.5±0.5    Glue width: 1.3±0.2

Model	Handle Material	Pad color	Viscosity	Packaging	Anti-static	New
MSD-2020-ESD655-1.5 (H)	ABS + glass	Transparent	High viscosity	100 pieces/box	Yes	Yes

**Product Features:** High viscosity and no residual glue, No silicon, no secondary pollution

**Application scenarios:** AOI machine cleaning chip, Clean concave surfaces, blind holes, high gloss surfaces

Handle Dimensions: 70\*Φ1.6    Overall length: 70.5±0.5    Glue width: 1.5±0.3

Model	Handle Material	Pad color	Viscosity	Packaging	Anti-static	New
MSD-2019-ESD009-2.0 (M)	ABS + glass	Transparent	Medium viscosity	40 pieces/box	Yes	Yes

**Product Features:** No silicon, no secondary pollution

**Application scenarios:** AOI machine cleaning chip, Clean concave surfaces, blind holes, high gloss surfaces

Handle Dimensions: 70\*Φ1.6    Overall length: 70.5±0.5    Glue width: 2.0±0.2

Model	Handle Material	Pad color	Viscosity	Packaging	Anti-static	New
MSD-2019-ESD009-2.0 (H)	ABS + glass	Transparent	High viscosity	10 pieces/box	Yes	Yes

**Product Features:** High viscosity and no residual glue, No silicon, no secondary pollution

**Application scenarios:** AOI machine cleaning chip, Clean concave surfaces, blind holes, high gloss surfaces

Handle Dimensions: 70\*Φ1.6    Overall length: 70.5±0.5    Glue width: 2.0±0.2

Model	Handle Material	Pad color	Viscosity	Packaging	Anti-static	New
MSD-2023-ESD387-2.0 (L)	Stainless steel	Blue Points	Low viscosity	10 pieces/box	Yes	Yes

**Product Features:** Stainless steel rod, blue rubber head, easy to distinguish, No silicon, no secondary pollution

**Application scenarios:** Clean up the gap

Handle Dimensions: 74\*Φ1.0    Overall length: 75±1    Glue width: 2.0±0.2

Model	Handle Material	Pad color	Viscosity	Packaging	Anti-static	New
MSD-2023-ESD387-2.0 (M)	Stainless steel	Blue Points	Medium viscosity	10 pieces/box	Yes	Yes

**Product Features:** Stainless steel rod, blue rubber head, easy to distinguish, No silicon, no secondary pollution

**Application scenarios:** Clean up the gap

Handle Dimensions: 74\*Φ1.0    Overall length: 75±1    Glue width: 2.0±0.2

Model	Handle Material	Pad color	Viscosity	Packaging	Anti-static	New
MSD-2023-ESD387-2.0 (M)	ABS + glass	Clear Points	Medium viscosity	100 pieces/box	Yes	Yes

**Product Features:** Rubber tip, can clean up gaps, No silicon, no secondary pollution

**Application scenarios:** Clean up the gap

Handle Dimensions: 73\*Φ1.6    Overall length: 75±1    Glue width: 2.0±0.2

Model	Handle Material	Pad color	Viscosity	Packaging	Anti-static	New
MSD-2023-ESD387-2.0 (H)	Stainless steel	Blue Points	High viscosity	10 pieces/box	Yes	Yes

**Product Features:** Stainless steel rod, blue rubber head, easy to distinguish, No silicon, no secondary pollution

**Application scenarios:** Clean up the gap

Handle Dimensions: 74\*Φ1.0    Overall length: 75±1    Glue width: 2.0±0.2

Model	Handle Material	Pad color	Viscosity	Packaging	Anti-static	New
MSD-2023-ESD008-2.2 (M)	ABS + glass	Transparent	Medium viscosity	100 pieces/box	Yes	Yes

**Product Features:** The rubber head is hard and not easy to break, No silicon, no secondary pollution

**Application scenarios:** Clean smooth surfaces

Handle Dimensions: 73\*Φ1.6    Overall length: 74±1    Glue width: 2.2±0.2

Model	Handle Material	Pad color	Viscosity	Packaging	Anti-static	New
MSD-2023-ESD008-2.5 (M)	ABS + glass	Transparent	Medium viscosity	100 pieces/box	Yes	Yes

**Product Features:** No silicon, no secondary pollution

**Application scenarios:** Clean concave surfaces, blind holes, high gloss surfaces

Handle Dimensions: 73\*Φ1.6    Overall length: 74±1    Glue width: 2.5±0.2

02 Human protection  
03 Electrostatic control  
04 Environmental purification

Secondary category  
A Cleanroom wiper  
B Cleanroom nonwoven wiper  
C Cleaning Supplies Aids  
D Office supplies series  
E Sticky series  
F Cotton swab series  
G Mop - Mop wiper

02 Human protection  
03 Electrostatic control  
04 Environmental purification

Secondary category  
A Cleanroom wiper  
B Cleanroom nonwoven wiper  
C Cleaning Supplies Aids  
D Office supplies series  
E Sticky series  
F Cotton swab series  
G Mop - Mop wiper

Model	Handle Material	Pad color	Viscosity	Packaging
MSD-2019-ESD008-2.5 (M)	Paper rod	Transparent	Medium viscosity	100 pieces/box

**Product Features**

- No silicon, no secondary pollution

**Application scenarios**

- Clean concave surfaces, blind holes, high gloss surfaces

Handle Dimensions: 73\*Φ1.6  
Glue width: 2.5±0.2  
Overall length: 74±1

Model	Handle Material	Pad color	Viscosity	Packaging
MSD-2023-ESD008-2.5 (H)	ABS + glass	Transparent	High viscosity	100 pieces/box

**Product Features**

- No silicon, no secondary pollution

**Application scenarios**

- Clean concave surfaces, blind holes, high gloss surfaces

Handle Dimensions: 73\*Φ1.6  
Glue width: 2.5±0.2  
Overall length: 74±1

Model	Handle Material	Pad color	Viscosity	Packaging
MSD-2023-ESD008-2.8 (M)	ABS + glass	Transparent	Medium viscosity	100 pieces/box

**Product Features**

- No silicon, no secondary pollution

**Application scenarios**

- Clean concave surfaces, blind holes, high gloss surfaces

Handle Dimensions: 73\*Φ1.6  
Glue width: 2.8±0.2  
Overall length: 74±1

Model	Handle Material	Pad color	Viscosity	Packaging
MSD-2019-ESD001-3.0 (H)	Acrylic	Transparent	High viscosity	100 pieces/box

**Product Features**

- Large rubber head, easy to clean large area
- No silicon, no secondary pollution

**Application scenarios**

- Clean wafer, super black

Handle Dimensions: 75\*Φ2.0  
Glue width: 3.0±0.2  
Overall length: 76.5±1

### Paper pole cotton swab

- This product is made of high-quality raw cotton, degreased by special technology to make absorbent cotton, and produced by all-wood pulp paper shafts
- The product has the characteristics of low dust generation, low ions, and strong adsorption capacity. Highly absorbent, even if dipped in liquid such as alcohol and wiped, But also does not expand and deform, has high liquid absorbing capacity and adsorbing force, convenient use and good effect
- The product is environmentally friendly and can be discarded by combustion. No silicon, the cotton head is round and spherical, not easy to rise and fall

#### Application scenarios:

- Used in laser and related industries, semiconductor and related industries, optics, electron microscopes, magnetic head cleaning, video head, Cleaning of magnetic heads, precision devices, etc



RoHS Report    Haigen Report

Excellent material    Excellent performance    Environmentally friendly and durable

Model	Handle Material	Head Material	Head Shape	Packaging
CY-002	Wood pulp paper	High-quality cotton	Double round head	100 pieces/box

**Product Features**

- does not expand and deform

**Application scenarios**

- Laser and related industries
- Semiconductor and related industries, optics

Rod length: 73\*Φ0.4  
Head length: 14.5±0.8  
Head thickness: 4.4±0.3  
Total length: 77.5±0.8

Model	Handle Material	Head Material	Head Shape	Packaging
CY-003	Wood pulp paper	High-quality cotton	Double pointed	100 pieces/box

**Product Features**

- It is not easy to fall off cotton dust

**Application scenarios**

- Laser and related industries
- Semiconductor and related industries, optics

Rod length: 73\*Φ0.4  
Head length: 11.2±0.8  
Head thickness: 4.8±0.5  
Total length: 81±1

Model	Handle Material	Head Material	Head Shape	Packaging
BY-001	Wood pulp paper	High-quality cotton	Double round head	100 pieces/box

**Product Features**

- strong water absorption, no expansion and deformation

**Application scenarios**

- Laser and related industries
- Semiconductor and related industries, optics

Rod length: 73\*Φ0.4  
Head length: 13.5±0.8  
Head thickness: 3.2±0.5  
Total length: 75.5±1

Model	Handle Material	Head Material	Head Shape	Packaging
BY-003	Wood pulp paper	High-quality cotton	Double pointed	100 pieces/box

**Product Features**

- strong water absorption, no expansion and deformation

**Application scenarios**

- Laser and related industries
- Semiconductor and related industries, optics

Rod length: 73\*Φ0.4  
Head length: 11±0.8  
Head thickness: 3±0.5  
Total length: 79±1

Model	Handle Material	Head Material	Head Shape	Packaging
BY-002	Wood pulp paper	High-quality cotton	Double round head	100 pieces/box

**Product Features**

- strong water absorption, no expansion and deformation

**Application scenarios**

- Laser and related industries
- Semiconductor and related industries, optics

Rod length: 73\*Φ0.4  
Head length: 13.5±0.8  
Head thickness: 2.6±0.4  
Total length: 75.5±1

Model	Handle Material	Head Material	Head Shape	Packaging
BY-002	Wood pulp paper	High-quality cotton	Double round head	100 pieces/box

**Product Features**

- strong water absorption, no expansion and deformation

**Application scenarios**

- Laser and related industries
- Semiconductor and related industries, optics

Rod length: 73\*Φ0.4  
Head length: 8.5±0.8  
Head thickness: 2.3±0.4  
Total length: 76±1

### Cleanroom squeeze swab

- High-density sponge head, 70% IPA, durable PP clear rod
- Integrated design, easy to use, just gently squeeze the rear end of the PP rod, and the solvent will overflow from the head by air pressure, and gradually Gradually penetrate into the sponge and uniformly leach through the sponge head
- This design allows cotton swabs to quickly and effectively wipe stains on the surface of objects

#### Application scenarios:

- Optical and magnetic head equipment, lenses and sensors, electronic components, thermal printers, inkjet printers, printheads, card readers, computer monitors and keyboards
- And more critical product surface fine dust, ink, glue and other dirt wiping



High-density sponge    Durable and convenient    Efficient in cleaning

Model	Handle Material	Head Material	Head Shape	Packaging
1107040053	PP transparent rod	Sponge head	Flat head	100 pieces/box

**Product Features**

- Able to remove small particles of dust, ink, glue
- strong detergency and

Rod thickness: 5.0±0.5  
Head length: 30.5±3.0  
Head width: 13.4±2.0  
Total length: 107±5

### PU head inclined cut green stem cotton swab

- The PU head is made of polyurethane material, which has strong water absorption and oil absorption performance
- The oblique cut is more suitable for the wiping part than the round head, the PU head is soft and elastic, and the angled tip can meet different wiping requirements
- The head is made of porous fiber, which has strong ability to absorb and remove liquid
- Cotton swab head can be used to remove residue from the surface of the wiped object without causing secondary contamination
- The cotton swab head has a small area and can clean contaminants that are difficult to clean with Cleanroom wipers

#### Application scenarios:

- Remove hard disk contaminants, circuit boards, optical lenses and other electronic products
- Micromachinery cleaning, surface sampling and cleaning verification



Strong liquid absorption    Soft and elastic PU head    Efficient cleaning

Model	Handle Material	Head Shape	Packaging
T-31	Polyurethane	Flat head	100 pieces/box

**Product Features**

- Strong water and oil absorption performance, no secondary pollution
- Can clean contaminants that are difficult to reach with dust-free cloth

Head length: 15±3  
Head width: 3.0±0.3  
Thick head: 3.0±0.3  
Total length: 78±3

- 02 Human protection
- 03 Electrostatic control
- 04 Environmental purification

Secondary category

- A Cleanroom wiper
- B Cleanroom nonwoven wiper
- C Cleaning Supplies Aids
- D Office supplies series
- E Sticky series
- F Cotton swab series
- G Mop - Mopwiper

- 02 Human protection
- 03 Electrostatic control
- 04 Environmental purification

Secondary category

- A Cleanroom wiper
- B Cleanroom nonwoven wiper
- C Cleaning Supplies Aids
- D Office supplies series
- E Sticky series
- F Cotton swab series
- G Mop - Mopwiper

### Cleanroom purification cotton swab

- Choose high-quality polyester, ultra-fine or polyurethane foam cotton material as cleaning cotton head
- Excellent wiping ability to remove stubborn dirt on the wiped surface of the product
- The sign rod is made of new polypropylene plastic material, which can be used as anti-static and has efficient liquid absorption capacity and adsorption force
- Less fiber drop, low dust, low ion, resistance to ethanol, polypropylene and other wiping solvents
- Ultrasonic welding process makes the cotton head and handle bond more firmly

#### Application scenarios:

- Class 10 ~ Class 100,000 cleanroom workshop
- Mainly used in hard disk industry, optical instruments, lenses, printers, scanners, Chip, laboratory, flat panel display and other major electronic fields



ISO CLASS 3-8

RoHS

Heat resistance 100-150°C

Strong liquid absorption High cleanliness Soft texture

Model	Handle Material	Head Shape	Packaging
M-FS707	High-density sponge single-sided double-layer sponge head	Flat head	50pcs/pack, 60pcs/carton

Product Features:
 

- Adopt hot press bonding process, the sponge head is not easy to fall off
- Strong adhesion, double-layer sponge resistance to abrasion

Dimensions: Pole width: 6.6±0.3, Rod thickness: 2.6±0.3, Rod length: 125±3, Total length: 128±5, Head length: 25±2, Head width: 15.6±0.5, Thick head: 9.5±0.3

Model	Handle Material	Head Shape	Packaging
M-FS708	High-density sponge single-sided double-layer sponge head	Flat round head	50pcs/pack, 60pcs/carton

Product Features:
 

- Adopt hot press bonding process, the sponge head is not easy to fall off
- Strong adhesion, double-layer sponge resistance to abrasion

Dimensions: Pole width: 6.8±0.3, Rod thickness: 2.6±0.3, Rod length: 125±3, Total length: 128±5, Head length: 25±2, Head width: 17.5±0.5, Thick head: 9.5±0.3

Model	Handle Material	Head Shape	Packaging
M-FS712	High-density sponge single-sided single-layer sponge head	Flat head	100pcs/pack, 60pcs/carton

Product Features:
 

- Adopt hot press bonding process, the sponge head is not easy to fall off
- Strong adhesion, double-layer sponge resistance to abrasion

Dimensions: Pole width: 5.8±0.3, Rod thickness: 2.5±0.3, Rod length: 120±3, Total length: 122±5, Head length: 25±3, Head width: 12±1, Thick head: 6.5±0.3

Model	Handle Material	Head Shape	Packaging
M-FS740	High-density sponge single-sided single-layer sponge head	Flat head	100pcs/pack, 100pcs/carton

Product Features:
 

- Adopt hot press bonding process, the sponge head is not easy to fall off
- Strong adhesion, double-layer sponge resistance to abrasion

Dimensions: Pole width: 3.3±0.3, Rod length: 160±3, Total length: 163±5, Head length: 17±0.5, Head width: 6.0±0.5, Thick head: 5.0±0.5

Model	Handle Material	Head Shape	Packaging
(ESD)M-FS740	High-density sponge single-sided single-layer sponge head	Flat head	100pcs/pack, 100pcs/carton

Product Features:
 

- Adopt hot press bonding process, the sponge head is not easy to fall off
- PP rod anti-static masterbatch manufacturing, strong adhesion

Dimensions: Pole width: 3.3±0.3, Rod length: 160±3, Total length: 163±5, Head length: 17±0.5, Head width: 6.0±0.5, Thick head: 5.0±0.5

Model	Handle Material	Head Shape	Packaging
M-FS741	High-density sponge single-sided single-layer sponge head	Round head	100pcs/small bag, 500pcs/large bag

Product Features:
 

- Adopt hot press bonding process, the sponge head is not easy to fall off
- Strong adhesion, double-layer sponge resistance to abrasion

Dimensions: Pole width: 2.3±0.2, Rod length: 68±2, Total length: 70±3, Head length: 11±0.5, Head width: 3.5±0.3, Thick head: 1.0±0.2

Model	Handle Material	Head Shape	Packaging
M-FS742	High-density sponge single-sided single-layer sponge head	Straight round head	100pcs/small bag, 500pcs/large bag

Product Features:
 

- Adopt hot press bonding process, the sponge head is not easy to fall off
- Strong adhesion, double-layer sponge resistance to abrasion

Dimensions: Pole width: 2.7±0.3, Rod length: 68±2, Total length: 70±3, Head length: 11.5±2, Head width: 4.0±0.5, Thick head: 3.5±0.5

Model	Handle Material	Head Shape	Packaging
M-FS746	High-density sponge single-sided single-layer sponge head	Flat head	100pcs/pack, 100pcs/carton

Product Features:
 

- Adopt hot press bonding process, the sponge head is not easy to fall off
- Strong adhesion, double-layer sponge resistance to abrasion

Dimensions: Pole width: 3.3±0.3, Rod length: 97±3, Total length: 100±3, Head length: 17±0.5, Head width: 6.0±0.5, Thick head: 5.0±0.5

Model	Handle Material	Head Shape	Packaging
M-FS750	High-density sponge single-sided single-layer sponge head	Conical tip	100pcs/small bag, 500pcs/large bag

Product Features:
 

- Adopt hot press bonding process, the sponge head is not easy to fall off
- Strong adhesion, double-layer sponge resistance to abrasion

Dimensions: Pole width: 2.5±0.3, Rod length: 74±2, Total length: 76±3, Head length: 10±1

Model	Handle Material	Head Shape	Packaging
M-FS751	High-density sponge single-sided single-layer sponge head	Cone thread tip	100pcs/small bag, 500pcs/large bag

Product Features:
 

- Adopt hot press bonding process, the sponge head is not easy to fall off
- Strong adhesion, double-layer sponge resistance to abrasion

Dimensions: Pole width: 2.5±0.3, Rod length: 64±2, Total length: 66±3, Head length: 15±0.5

Model	Handle Material	Head Shape	Packaging
M-FS752	High-density sponge single-sided single-layer sponge head	Cone thread tip	100pcs/small bag, 500pcs/large bag

Product Features:
 

- Adopt hot press bonding process, the sponge head is not easy to fall off
- Strong adhesion, double-layer sponge resistance to abrasion

Dimensions: Pole width: 2.5±0.3, Rod length: 66±2, Total length: 68±3, Head length: 21±0.5

Model	Handle Material	Head Shape	Packaging
M-FS757	High-density sponge single-sided single-layer sponge head	Round head	100pcs/small bag, 500pcs/large bag

Product Features:
 

- Adopt hot press bonding process, the sponge head is not easy to fall off
- Strong adhesion, double-layer sponge resistance to abrasion

Dimensions: Pole width: 2.3±0.2, Rod length: 68±2, Total length: 70±3, Head length: 11±0.5, Head width: 3.5±0.3, Thick head: 1.0±0.2

Model	Handle Material	Head Shape	Packaging
M-FS758	High-density sponge single-sided single-layer sponge head	Round head	100pcs/small bag, 500pcs/large bag

Product Features:
 

- Adopt hot press bonding process, the sponge head is not easy to fall off
- Strong adhesion, double-layer sponge resistance to abrasion

Dimensions: Pole width: 2.7±0.3, Rod length: 68±2, Total length: 70±3, Head length: 11.5±2, Head width: 4.0±0.5, Thick head: 3.5±0.5

Model	Handle Material	Head Shape	Packaging
M-FS759	High-density sponge single-sided single-layer sponge head	Double round head	100pcs/pack, 150pcs/carton

Product Features:
 

- Adopt hot press bonding process, the sponge head is not easy to fall off
- Strong adhesion, double-layer sponge resistance to abrasion

Dimensions: Pole width: 3.8±0.3, Rod length: 78±3, Total length: 80±3, Head length: 10±1, Head width: 5.0±0.3, Thick head: 4.0±0.3

Model	Handle Material	Head Shape	Packaging
M-PS705	Polyester Cleanroom wiper single-sided double-layer inner edge sealing wiper head	Flat head	100pcs/pack, 50pcs/carton

Product Features:
 

- Domestic first-class ultrasonic manual flanging technology
- Applied to high-standard customer groups such as medical equipment and aerospace precision

Dimensions: Pole width: 7.2±0.3, Rod thickness: 2.7±0.3, Total length: 125±5, Head length: 25±3, Head width: 14±1, Thick head: 2.9±0.2

- 02 Human protection
  - 03 Electrostatic control
  - 04 Environmental purification
- Secondary category
- A Cleanroom wiper
  - B Cleanroom nonwoven wiper
  - C Cleaning Supplies Aids
  - D Office supplies series
  - E Stickyseries
  - F Cotton swab series
  - G Mop + Mop wiper

- 02 Human protection
  - 03 Electrostatic control
  - 04 Environmental purification
- Secondary category
- A Cleanroom wiper
  - B Cleanroom nonwoven wiper
  - C Cleaning Supplies Aids
  - D Office supplies series
  - E Stickyseries
  - F Cotton swab series
  - G Mop + Mop wiper

Model	Handle Material	Head Shape	Packaging
M-PS706	Polyester Cleanroom wiper single-sided double-layer inner edge sealing wiper head	Flat head	100pcs/pack, 50pcs/carton

**Product Features**

- Domestic first-class ultrasonic manual flanging technology

Pole width:  $7.2 \pm 0.3$   
Rod thickness:  $2.7 \pm 0.3$

Head length:  $25 \pm 3$   
Head width:  $14 \pm 1$   
Thick head:  $2.9 \pm 0.2$   
Total length:  $125 \pm 5$

Model	Handle Material	Head Shape	Packaging
M-PS707	Polyester Cleanroom wiper single-sided double-layer wiper head	Flat head	100pcs/pack, 50pcs/carton

**Product Features**

- Ultrasonic edge sealing double-layer outer edge sealing process
- Solid core rod on the head, wipe evenly and bear force

Pole width:  $7.2 \pm 0.3$   
Rod thickness:  $2.7 \pm 0.3$

Head length:  $25 \pm 3$   
Head width:  $14 \pm 1$   
Thick head:  $2.9 \pm 0.2$   
Total length:  $125 \pm 5$

Model	Handle Material	Head Shape	Packaging
M-PS712	Polyester Cleanroom wiper single-sided double-layer wiper head	Flat head	100pcs/pack, 50pcs/carton

**Product Features**

- Using ultrasonic outer edge sealing process
- The thickening of the head is more tressful and less easy to deform

Pole width:  $5.8 \pm 0.3$   
Rod thickness:  $2.5 \pm 0.3$

Head length:  $25 \pm 3$   
Head width:  $12 \pm 1$   
Thick head:  $3.5 \pm 0.2$   
Total length:  $122 \pm 5$

Model	Handle Material	Head Shape	Packaging
M-PS713	Polyester Cleanroom wiper single-sided double-layer wiper head	Flat head	100pcs/pack, 50pcs/carton

**Product Features**

- Using ultrasonic outer edge sealing process
- The thickening of the head is more tressful and less easy to deform

Pole width:  $5.8 \pm 0.3$   
Rod thickness:  $2.5 \pm 0.3$

Head length:  $25 \pm 3$   
Head width:  $12 \pm 1$   
Thick head:  $3.5 \pm 0.2$   
Total length:  $122 \pm 5$

Model	Handle Material	Head Shape	Packaging
M-PS714	Polyester Cleanroom wiper single-sided double-layer wiper head	Flat head	100pcs/pack, 50pcs/carton

**Product Features**

- Adopt ultrasonic edge sealing process
- Hollow-out head pole

Pole width:  $5.8 \pm 0.3$   
Rod thickness:  $2.2 \pm 0.3$

Head length:  $25 \pm 3$   
Head width:  $13.5 \pm 1$   
Thick head:  $2.9 \pm 0.2$   
Total length:  $125 \pm 5$

Model	Handle Material	Head Shape	Packaging
M-PS743	Polyester Cleanroom wiper single-sided double-layer wiper head	Cylindrical head	100pcs/pack, 50pcs/carton

**Product Features**

- Adopt hot press bonding process (the cylindrical head is not easy to deform)
- Cotton head is not easy to fall off, efficient cleaning

Pole width:  $2.7 \pm 0.3$

Head length:  $11.5 \pm 2$   
Head width:  $4.0 \pm 0.5$   
Thick head:  $3.5 \pm 0.5$   
Total length:  $70 \pm 3$

Model	Handle Material	Head Shape	Packaging
M-PS745	Polyester Cleanroom wiper single-sided double-layer wiper head	Oval head	100pcs/pack, 50pcs/carton

**Product Features**

- Adopt hot press bonding process (the cylindrical head is not easy to deform)
- Cotton head is not easy to fall off, efficient cleaning

Pole width:  $2.3 \pm 0.2$

Head length:  $11 \pm 0.5$   
Head width:  $3.5 \pm 0.3$   
Thick head:  $2.1 \pm 0.3$   
Total length:  $70 \pm 3$

Model	Handle Material	Head Shape	Packaging
M-PS746	Polyester Cleanroom wiper single-sided double-layer wiper head	Double round head	100pcs/pack, 200pcs/carton

**Product Features**

- Adopt ultrasonic edge sealing process
- Delicate closure and not easy to scratch products, double-head bevel design

Pole width:  $3.0 \pm 0.3$

Head length:  $12 \pm 2$   
Head width:  $4.0 \pm 0.5$   
Thick head:  $3.0 \pm 0.5$   
Total length:  $90 \pm 3$

Model	Handle Material	Head Shape	Packaging
M-PS747	Polyester Cleanroom wiper single-sided double-layer wiper head	Flat head	100pcs/pack, 130pcs/carton

**Product Features**

- Disposable sampling test piece
- Oral cleaning

Pole width:  $4.3 \pm 0.3$   
Rod thickness:  $2.4 \pm 0.3$

Head length:  $25 \pm 0.5$   
Head width:  $10.5 \pm 0.5$   
Thick head:  $3.0 \pm 0.5$   
Rod length:  $98 \pm 2$   
Total length:  $100 \pm 3$

Model	Handle Material	Head Shape	Packaging
M-PS750	Imitation ultra-fine Cleanroom wiper single-sided double-layer wiper head	Conical tip	100pcs/pack, 50pcs/carton

**Product Features**

- Using ultrasonic outer edge sealing process
- The thickening of the head is more tressful and less easy to deform

Pole width:  $2.6 \pm 0.3$

Head length:  $12.5 \pm 1$   
Rod length:  $75 \pm 2$   
Total length:  $76 \pm 3$

Model	Handle Material	Head Shape	Packaging
M-PS761	Polyester Cleanroom wiper single-sided double-layer wiper head	Flat head	100pcs/pack, 100pcs/carton

**Product Features**

- Using ultrasonic outer edge sealing process
- The thickening of the head is more tressful and less easy to deform

Pole width:  $3.3 \pm 0.3$

Head length:  $17 \pm 0.5$   
Head width:  $6.8 \pm 0.5$   
Thick head:  $2.5 \pm 0.5$   
Total length:  $163 \pm 3$

Model	Handle Material	Head Shape	Packaging
M-PS766	Polyester Cleanroom wiper single-sided double-layer wiper head	Flat head	100pcs/pack, 100pcs/carton

**Product Features**

- Using ultrasonic outer edge sealing process
- The thickening of the head is more tressful and less easy to deform

Pole width:  $3.3 \pm 0.3$

Head length:  $17 \pm 0.5$   
Head width:  $6.8 \pm 0.5$   
Thick head:  $2.5 \pm 0.5$   
Total length:  $100 \pm 3$

Model	Handle Material	Head Shape	Packaging
M-PS768	Imitation ultra-fine Cleanroom wiper single-sided double-layer wiper head	Flat head	100pcs/pack, 200pcs/carton

**Product Features**

- Using ultrasonic outer edge sealing process
- The thickening of the head is more tressful and less easy to deform

Pole width:  $3.4 \pm 0.3$

Head length:  $12.5 \pm 1$   
Head width:  $3.8 \pm 0.5$   
Thick head:  $2.5 \pm 0.5$   
Rod length:  $97 \pm 2$   
Total length:  $99 \pm 3$

Model	Handle Material	Head Shape	Packaging
M-SM714	ultra-fine Cleanroom wiper single-sided double-layer wiper head	Flat head	100pcs/pack, 50pcs/carton

**Product Features**

- Ultrasonic edge sealing double-layer outer edge sealing process
- Solid core rod on the head, wipe evenly and bear force

Pole width:  $7.2 \pm 0.3$   
Rod thickness:  $2.7 \pm 0.3$

Head length:  $25 \pm 3$   
Head width:  $14 \pm 1$   
Thick head:  $2.9 \pm 0.2$   
Rod length:  $123 \pm 2$   
Total length:  $125 \pm 5$

Model	Handle Material	Head Shape	Packaging
M-SM741	ultra-fine Cleanroom wiper single-sided double-layer wiper head	Flat head	100pcs/pack, 200pcs/carton

**Product Features**

- Using ultrasonic outer edge sealing process
- The thickening of the head is more tressful and less easy to deform

Pole width:  $3.8 \pm 0.3$

Head length:  $12.5 \pm 1$   
Head width:  $4.5 \pm 0.5$   
Thick head:  $1.2 \pm 0.2$   
Rod length:  $96 \pm 2$   
Total length:  $98 \pm 3$

Model	Handle Material	Head Shape	Packaging
M-SM758	ultra-fine Cleanroom wiper single-sided double-layer wiper head	Flat head	100pcs/pack, 50pcs/carton

**Product Features**

- Adopt ultrasonic edge sealing process (flat head) to seal soft and delicate
- Used in the cleaning of camera microscopes and a wide range of electronics industries

Pole width:  $2.3 \pm 0.2$

Head length:  $11 \pm 0.5$   
Head width:  $3.5 \pm 0.3$   
Thick head:  $1.0 \pm 0.2$   
Rod length:  $68 \pm 2$   
Total length:  $70 \pm 3$

Model	Handle Material	Head Shape	Packaging
M-SM761	ultra-fine Cleanroom wiper single-sided double-layer wiper head	Flat head	100pcs/pack, 100pcs/carton

**Product Features**

- Using ultrasonic outer edge sealing process
- The thickening of the head is more tressful and less easy to deform

Pole width:  $3.3 \pm 0.3$

Head length:  $17 \pm 0.5$   
Head width:  $6.8 \pm 0.5$   
Thick head:  $2.5 \pm 0.5$   
Rod length:  $160 \pm 2$   
Total length:  $163 \pm 3$

Model	Handle Material	Head Shape	Packaging
M-SM766	ultra-fine Cleanroom wiper single-sided double-layer wiper head	Flat head	100pcs/pack, 100pcs/carton

**Product Features**

- Using ultrasonic outer edge sealing process
- The thickening of the head is more tressful and less easy to deform

Pole width:  $3.3 \pm 0.3$

Head length:  $17 \pm 0.5$   
Head width:  $7.0 \pm 0.5$   
Thick head:  $2.5 \pm 0.5$   
Rod length:  $98 \pm 2$   
Total length:  $100 \pm 3$

- 02 Human protection
- 03 Electrostatic control
- 04 Environmental purification

- Secondary category
- A Cleanroom wiper
- B Cleanroom nonwoven wiper
- C Cleaning Supplies Aids
- D Office supplies series
- E Sticky series
- F Cotton swab series
- G Mop - Mopwiper

- 02 Human protection
- 03 Electrostatic control
- 04 Environmental purification

- Secondary category
- A Cleanroom wiper
- B Cleanroom nonwoven wiper
- C Cleaning Supplies Aids
- D Office supplies series
- E Sticky series
- F Cotton swab series
- G Mop - Mopwiper

### Cleanroom mop

Model	Specification	Packaging
MP01	Rod length 125cm (retractable), mop head 39 * 21cm	1 pcs/carton
MP02	Rod length ~ 1500mm, chuck 400 * 95mm	1 pcs/ carton

• Stainless steel mop can be sterilized at high temperature, strong and lightweight, quick and easy to change the mop cover, the mop cover has good durability and has ultra-Strong anti-wear strength, good water absorption and super detergency, easy to wash, quick to dry and durable

• It has the characteristics of strong water absorption, strong decontamination, easy cleaning, no lint shedding, no bacteria, and no damage to the surface of objects. It is both beautiful and practical

• Mainly used for flat and horizontal cleaning of clean rooms, air showers, dressing rooms, especially for cleaning walls, floors and ceilings

• Extensive wiping in the biopharmaceutical industry and medical device industry

[RoHS Report](#) [COA Report](#)



Hot Selling

RoHS

- Easy to disassemble and wash
- No lint shedding
- Efficient cleaning

### Multifunctional spray flat mop

Model	Specification
MP03	130/140cm, ash

• Composed of spray flat mop and a series of quick cleaning accessories, it innovates the new concept of flat mop cleaning, saves time and effort, and improves cleaning efficiency

• Quick cleaning system, eliminating the need for mop buckets or water presses

• Light and flexible, simple and convenient to use, saving water and chemicals, saving energy and environmentally friendly

• Quick replacement accessories design to meet the needs of different areas and spray designs, and the floor glass is easily handled

#### Application scenarios:

• Mainly used in airports, schools, hospitals, shopping malls, offices, restaurants, supermarkets, and other public places and cleanroom areas

[RoHS Report](#) [COA Report](#)



RoHS

- Easy to disassemble and wash
- No lint shedding
- Efficient cleaning



### Anti-static cleanroom mop

Model	Specification
MP04	Regular length dimensions are 45cm/60cm/90cm

• The mop head, mop rod and mop frame are all separate modules, which can be arbitrarily matched with mop frames and mop heads of different sizes and materials

• The bottom wipe is made of cleanroom ultra-fine fabric, laser edge sealing, no lint or chip, and has a strong static blocking function

• The rectangular Cleanroom wiper has high water absorption capacity and leaves no water marks after wiping. The mop rod has a clamping function and is easy to disassemble. The mop head can be quickly replaced

• The mop bar has a clamping function, easy to remove, and the mop head can be quickly changed

#### Application scenarios:

• Mainly used in clean areas of cleanroom workshops, clean rooms of precision electronics factories, food production workshops, semiconductor factories, etc.

[RoHS Report](#) [COA Report](#)



RoHS

Anti-static

- Easy to disassemble and wash
- No lint shedding
- Efficient cleaning



Provide you with accurate after-sales advice and comprehensive solutions

### Thread braided mop wiper

Model	Material	Specification
MP05	Microfiber thread braided + oxford	41*12cm, pocket width 6cm

• The thread knitting process is tight, which can effectively absorb and remove dust and stains on the ground, and has strong cleaning power

• The material and weaving method reduce dust when mopping the floor, achieving cleanroom cleaning

• Tough texture, not easy to be damaged and deformed after repeated use and friction, long service life

#### Application scenarios:

• Flat and horizontal cleaning of clean rooms, air showers, dressing room areas, especially walls, floors and ceilings, extensive wiping in the biopharmaceutical industry and medical device industry

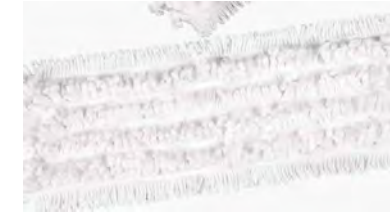

RoHS

- Easy to disassemble and wash
- No lint shedding
- Efficient cleaning



### Cleanroom mop wiper

Model	Material	Specification
MP06	Chenille microfiber	430*125mm
MP07	Microfiber striped flannel + Oxford fabric	42.2*14.5cm
MP08	polyester composite fabric/superfine fabric/superfine anti-static fabric	Customizable

#### Application scenarios:

• Flat and horizontal cleaning of clean rooms, air showers, dressing room areas, especially walls, floors and ceilings

• Extensive wiping in the biopharmaceutical industry and medical device industry

[RoHS Report](#) [COA Report](#)



RoHS

- Easy to disassemble and wash
- No lint shedding
- Efficient cleaning



### Cleanroom mop lamination

Model	Material	Specification
MP09	Ultrasonic Cleanroom wiper 210g + absorbent cotton 400g	39*13cm, pocket width 6cm

• The multi-layer structure of composite material greatly enhances the adsorption of dust, hair, etc., and cleans efficiently

• The texture is tough, resistant to repeated cleaning and mopping friction, and is not easy to be damaged and deformed after long term use

#### Application scenarios:

• Flat and horizontal cleaning of clean rooms, air showers, dressing room areas, especially walls, floors and ceilings

• Extensive wiping in the biopharmaceutical industry and medical device industry

[RoHS Report](#) [COA Report](#) [Cleanliness Report](#)



RoHS

- Easy to disassemble and wash
- No lint shedding
- Efficient cleaning



### Microfiber mop wiper

Model	Material	Specification
MP10	Blue microfiber wiper + absorbent cotton 280g + oxford wiper	43.5*12.5 cm, pocket width 7cm

• Extremely fine fibers can effectively capture tiny dust and ensure thorough cleaning

• Advanced materials and technology, almost no fibers fall off when wiping, avoiding secondary pollution

• Soft texture, does not damage the surface of objects, and is not easily damaged after multiple uses. It can quickly absorb liquid stains and keep the ground dry

#### Application scenarios:

• Flat and horizontal cleaning of clean rooms, air showers, dressing room areas, especially walls, floors and ceilings

• Extensive wiping in the biopharmaceutical industry and medical device industry

[RoHS Report](#) [COA Report](#)

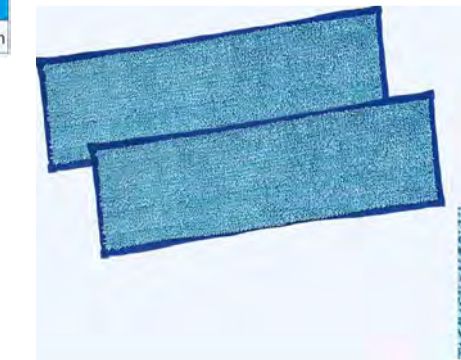

RoHS

- Easy to disassemble and wash
- No lint shedding
- Efficient cleaning

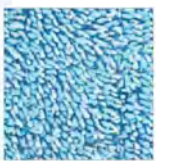

02 Human protection

03 Electrostatic control

04 Environmental purification

Secondary category

A Cleanroom wiper

B Cleanroom nonwoven wiper

C Cleaning Supplies Aids

D Office supplies series

E Sticky series

F Cottonswab series

G Mop + Mop wiper

02 Human protection

03 Electrostatic control

04 Environmental purification

Secondary category

A Cleanroom wiper

B Cleanroom nonwoven wiper

C Cleaning Supplies Aids

D Office supplies series

E Sticky series

F Cottonswab series

G Mop + Mop wiper

# HUMAN PROTECTION

## Details Make Quality

- Cleanroom clothing/shoes
- Cleanroom cap/strip cap
- Glove Series
- Finger cots series
- Shoes cover series



To prevent micro-contamination and empower high technology.

## myesde RECOMMENDED

Myesde provides you with various item solutions according to the cleaning environment

### Garment

Combines comfortable wearing, breathability and operability  
MSD-01-2 Straight Pull Hooded Jumpsuit



### Hooded

Effectively prevents tiny dust and particles  
MSD-03-1 Lower zipper Crotch Hooded Jumpsuit



### Wiper

Exercise superior wiping and high absorption properties

- WM01 Microfiber cleanroom cloth
- WF01 Polyester ultra-fine cleanroom cloth



- WL01 polyester lightweight cleanroom cloth
- WH02 polyester heavy-duty cleanroom cloth



### Glove

Effectively block the fall of pollutants

- MNB12-002 Nitrile Gloves (Powder Free)
- MP12-001 Disposable PVC Gloves



Total 20 models to choose

### Sticky mat

Remove all kinds of attachments such as dust and hair

- M01 Antibacterial Sticky mat
- M02 open hole adhesive mat



01 CLEANROOM CONSUMABLES

02 HUMAN PROTECTION

03 Electrostatic control

04 Environmental purification

Secondary category

- A Cleanroom clothing
- B Disposable protective clothing
- C Cleanroom cap
- D Cleanroom shoes
- E Protective gloves
- F Finger sleeve
- G Shoe cover

• Myesde anti-static cleanroom clothing •

Using special fabrics and processes, conductive fibers are woven into polyester filament fabrics to form a conductive network, which can quickly conduct the static electricity generated by human body to the earth, avoid the accumulation and release of static electricity, and protect electronic components from static electricity damage. The fabric does not emit dust, does not absorb dust, and has a good filtration effect. It can prevent external dust, human dander, hair and other tiny particles from entering the working environment and maintain the cleanliness of the workshop. The fabric is usually breathable, and the version design considers the needs of human activities, so it will not be too stuffy, tight or restrained to wear, which is convenient for staff to work comfortably for a long time.



• Myesde anti-static clothing size standard reference • (unisex)

Size	Fits Height (cm)	Fits Weight (kg)	Fits Bust (cm)
S	155-160	40-45	78-88
M	160-165	45-50	82-92
L	165-170	50-60	86-96
XL	170-175	60-70	90-100
2XL	175-180	70-80	94-104
3XL	180-185	80-90	98-108
4XL	185-190	90-100	102-112

\*The above sizes are for reference only, hesitation measurement methods are different, there may be certain measurement errors.



• Myesde anti-static fabric color card •

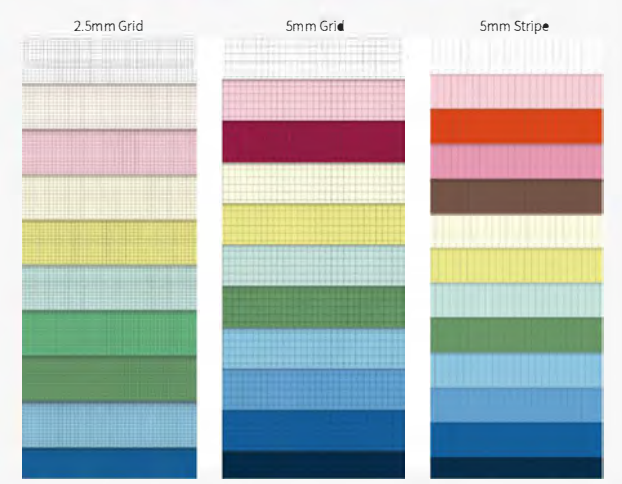

• Anti-static jumpsuit can be made of 2.5 mm grid, 5mm grid and 5mm striped fabric  
 • Dynamic dust generation ( $\geq 0.5\mu\text{m}$ )  $\leq 500\text{ea}/\text{ft}^3$

• Precautions for wearing anti-static dust-free clothing •

- Anti-static clean clothing must undergo the same Class of clean cleaning before entering the cleanroom for use
- Avoid direct contact with corrosive chemicals and profit materials
- Do not move brutally when wearing/taking off. If it is not smooth, carefully check whether there is any problem with the zipper or button
- The clothing should be kept hanging or folded neatly after being removed. When the clothing is not used for a long time, it should be cleaned, sealed and kept in a dry environment
- Periodically check the anti-static performance of clothing. If the fabric is damaged or the seams are broken, stop using it
- Establish a cleaning system for clothing, keep cleaning records, and it is recommended to clean it by a professional cleaning agency

Application scenarios:

• Mainly used in semiconductor, liquid crystal, pharmaceutical, electronic peripheral manufacturing industries, etc

Straight Pull Hooded Jumpsuit

Model	Fabric	Properties	Main material	Uses
MSD-01-2	1/1 plain weave 0.5 grid 68D	dustproof, anti-static, pollutant isolation	anti-static fabric	class100 and Cclass000 clean room use

- The manufacturing process and materials make the jumpsuit wear resistant and washable, and can be used many times, reducing usage costs and extending service life
- Straight pull zipper design, relatively easy to put on and take off, saving time and energy, and improving work efficiency



• Application scenarios:

- Mainly used in electronics, encapsulation, electronic parts processing, semiconductors, precision industry, high sensitivity environment of electronic components

• Details display:



## Lower zipper Crotch Hooded Jumpsuit

Model	Fabric	Properties	Main material	Uses
MSD-03	0.25 grid 100D	Dustproof, anti-static, pollutant isolation	Anti-static fabric	Class10 clean rooms, mainly in the semiconductor industry

- The design of the lower crotch will focus on flexibility of movement, while ensuring sealing without excessively restricting leg movements
- The crotch is equipped with a zipper structure, which can provide convenience for the wearer's physiological activities without being detached as a whole, significantly improving the convenience of wearing and working efficiency



Semiconductor Industry  
ISO CLASS 4-5  
Anti-static

• Unisex • S-4XL

White Pink Blue

### • Application scenarios:

- Mainly used in the semiconductor industry, etc., suitable for environments with higher requirements for static electricity and cleanliness
- Class10 clean room

### • Details display:



## Lower zipper Crotch Hooded Jumpsuit

Model	Fabric	Properties	Main material	Uses
MSD-03-1	1/1 plain 0.5 grid 68D	Dustproof, anti-static, pollutant isolation	Anti-static fabric	Class100 and Cclass000 clean rooms

- The integrated one-piece design can effectively block dust, hair and other pollutants, reduce the contact between the human body and external pollutants, prevent pollutants from entering in cleanroom workshops and other environments, and ensure product quality
- The fabric has anti-static properties, which can eliminate or reduce the generation and accumulation of static electricity in the human body, and avoid damage to electronic components caused by static electricity



Semiconductor Industry  
ISO CLASS 5-6  
Anti-static  
New

• Unisex • S-4XL

White Pink Blue

### • Application scenarios:

- Semiconductor, electronics, aerospace industries, and more

### • Details display:



01 CLEANROOM CONSUMABLES

02 HUMAN PROTECTION

### Lower zipper Crotch Hooded Jumpsuit

Model	Fabric	Properties	Main material	Uses
MSD-02	0.5 grid 100D	Dustproof, anti-static, pollutant isolation	Anti-static fabric	Class100 cleanroom, good protection effect

- The zipper is not in the middle position, but on the side, and can be pulled diagonally from the head to the waist. This design makes the overall shape different from the common straightpull style, and provides different operation methods when putting on and taking off
- Helps prevent fine dust particles produced by the human body from entering the air. In environments with high cleanliness requirements such as cleanroom workshops, scientific research laboratories, and microbial engineering, it can maintain the cleanliness of the environment and ensure product quality or experimental accuracy



Semiconductor Industry  
ISO CLASS 5-6  
Anti-static

• Unisex • S-4XL

White Pink Blue

#### • Application scenarios:

• Mainly used in the electronic industry, encapsulation, electronic parts processing, semiconductors, precision industry, optoelectronic industry and other industries, highly sensitive environments such as electronic components

#### • Details display:

- 01 Hooded**  
Hooded design, simple and capable, without any cumbersome feeling
- 02 Ear Net**  
Ear net design  
Highly breathable, no stuffiness
- 03 Mask**  
Comprehensive protection, effectively isolate the dust generated by the mouth and nose
- 04 Velcro**  
Adjustable tightness, excellent dustproof performance
- 05 Elastic waist**  
High light waistline, work clothes also look stylish
- 06 Cuffs**  
Dust proof, loose enough
- 07 Arm pocket**  
Arm pocket design, can hold writing pen or marker

### Straight Pull Hooded Jumpsuit

Model	Fabric	Properties	Main material	Uses
MSD-01	0.5 Stripes 100D	Dustproof, anti-static, pollutant isolation	Anti-static fabric	Suitable for class1000 cleanroom

- The surface is thin and smooth and the texture is clear. Not only does it have certain visual characteristics, but the fabric also has good wear resistance and wrinkle resistance, making it easy to wear and care for every day
- Straightpull zipper design, relatively easy to put on and take off, saving time and energy, and improving work efficiency



Precision electronics industry  
ISO CLASS 6-7  
Anti-static  
New

• Unisex • S-4XL

White Pink Blue

#### • Application scenarios:

• Mainly used in industries where static electricity requirements are not particularly strict, such as electronics, food, less sensitive work environments in the pharmaceutical industry

#### • Details display:

- 01 Hooded**  
Hooded design, simple and capable, without any cumbersome feeling
- 02 Ear Net**  
Ear net design  
Highly breathable, no stuffiness
- 03 Velcro**  
Velcro design on the collar can adjust the tightness of the collar and make it comfortable to wear
- 04 Arm pocket**  
Arm pocket design, can hold writing pen or marker
- 05 Chest loop design**  
Place the work number clip for easy identification

#### • Effective dustproof • and good barrier

Every detail of workmanship protects your safety

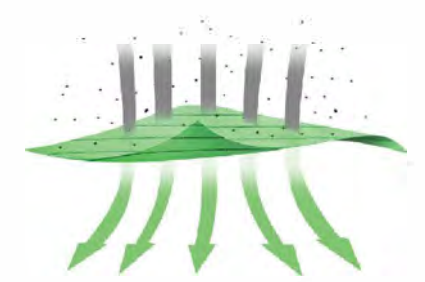

01 CLEANROOM CONSUMABLES

02 HUMAN PROTECTION

03 Electrostatic control

04 Environmental purification

Secondary category

A Cleanroom clothing

B Disposable protective clothing

C Cleanroom cap

D Cleanroom shoes

E Protective gloves

F Finger sleeve

G Shoe cover

## Straight Pull Hooded Jumpsuit

Model	Fabric	Properties	Main material	Uses
MSD-01-1	2/3 oblique grey wire 0.5 grid 75D	Dustproof, anti-static, pollutant isolation	Anti-static fabric	Suitable for class100 and Cclass000 cleanroom

- Use soft and breathable fabrics to reduce the discomfort of long-term wearing, ensure the wearer's freedom of movement, and do not affect normal working operations
- The manufacturing process and materials make the jumpsuit wear-resistant and washable, and can be used many times, reducing usage costs and extending service life



Precision electronics industry

ISO CLASS  
5-6

Anti-static

New

### • Application scenarios:

- Suitable for industries with high cleanliness requirements such as electronics, medicine, and food

### • Details display:

01

**Hooded**

Hooded design, simple and capable, without any cumbersome feeling

02

**Two loops on the back of the hat**

Two horizontal loops design to make the hat fit the head better

03

**YKK zipper**

professional quality, smooth and no jamming

04

**Cuffs**

Double-layer cuffs with 2cm wide elastic band for better sealing

05

**Elastic waist**

crisfront, slim waist on the side

06

**Side seam pockets**

Convenient for storing mobile phones or dust-free notebooks, etc

07

**Arm pocket**

Arm pocket design, can hold writing pen or marker

• Unisex • S-4XL

White Pink Blue

## Medical straight pull hooded jumpsuit

Model	Fabric	Properties	Main material	Uses
MSD-01-4Y	2/3 oblique grey wire 0.5 grid 75D	Dustproof, anti-static, pollutant isolation	Anti-static fabric	Suitable for AB class clean room

- It has antistatic properties to prevent electrostatic electricity from absorbing dust, microorganisms, etc., and avoid polluting the medical environment and affecting medical equipment
- The front opening straight-pull design makes it relatively easy to put on and take off, covers the whole body, has good sealing, and reduces contaminants from contacting the skin and the inner layer of clothes



Biopharmaceutical industry

Anti-static

New

### • Application scenarios:

- Biopharmaceutical, food industry, etc

### • Details display:

01

**Hooded**

Hooded design, simple and capable, without any cumbersome feeling

02

**Side seam patch pockets**

Convenient for storing mobile phones or dust-free notebooks, etc.

03

**Collar design**

The collar adopts five-claw buckle design, and the hat size can be adjusted

04

**Cuff design**

Cuffs with thumb webbing

### Resistant to 121°C high temperature sterilization

Using special high temperature resistant fabrics and accessories



#### Pulsating vacuum pressure steam sterilization

- Steam pressure 205.8 kPa (2.1 kg/cm<sup>2</sup>)
- Temperature up to 132 °C and maintained for 10 minutes, can be used repeatedly 100 times or more

#### Exhaust pressure steam sterilization

- Pressure increases to 103.4 kPa (1.05 kg/cm<sup>2</sup>) and temperature reaches 121.3 °C for 15-30 minutes

• Unisex • S-4XL

White Pink Blue

## Straight-pull hooded jumpsuit with shoes

Model	Fabric	Properties	Main material	Uses
MSD-01-3Y	0.5 Stripe 100D	Dustproof, anti-static, pollutant isolation	Anti-static fabric	For CD class Cleanroom

- The filtration efficiency of particles is not less than 70%, which can block harmful ultra-fine dust, microorganisms, etc., maintain a clean medical environment and reduce the risk of infection
- The breaking strength of the material is not less than 45N, resistant to tearing and wear, and can be washed and used multiple times to reduce costs



Biopharmaceutical industry

Anti-static

New

### Application scenarios:

- Biopharmaceutical, food industry and other industries

### Details display:

- 01 Hooded**  
Hooded design, simple and capable, without any cumbersome feeling
- 03 Cap back tightness**  
Cap back one line, tightness adjustment
- 03 Collar design**  
With drawstring, more fit to the face
- 04 Velcro**  
Velcro design on the collar can adjust the tightness of the collar and make it comfortable to wear
- 05 Elastic waist**  
Crisp front, slim waist on the side
- 06 Cuffs**  
Dust-proof, loose enough
- 07 Foot-connected design**  
Effectively blocks tiny dust particles emitted by the human body from head to toe

Unisex S-4XL

White Pink Blue

## Anti-static hooded split suit

Model	Fabric	Properties	Main material	Uses
MSD-04-2	0.5 Stripe 100D	Dustproof, anti-static, pollutant isolation	Anti-static fabric	Class 1000 and above

- The split design makes the body more flexible when moving. Compared with a jumpsuit, it has less restrictions when bending down, squatting, raising hands and other movements, making it easier for the wearer to perform various operations and activities
- The hooded design can protect the head and prevent dust, droplets, debris, etc. from falling into the hair and neck. Clothes and pants are used separately to fully cover the body and reduce exposed parts of the body



Precision electronics industry

ISO CLASS 6-9

Anti-static

### Application scenarios:

- Mainly used in industries where static electricity requirements are not particularly strict, such as electronics, food, less sensitive work environments in the pharmaceutical industry

### Details display:

- 01 Hooded**  
Hooded design, simple and capable, without any cumbersome feeling
- 02 Ear Net**  
Earmnet design, highly breathable, no stuffiness
- 03 Velcro**  
Velcro design on the collar can adjust the tightness of the collar and make it comfortable to wear
- 04 Elastic top strap**  
Fits the human body better and prevents pollutants from falling off
- 05 Side seam pockets**  
Convenient for storing mobile phones or dust-free notebooks, etc

Unisex S-4XL

White Pink Blue

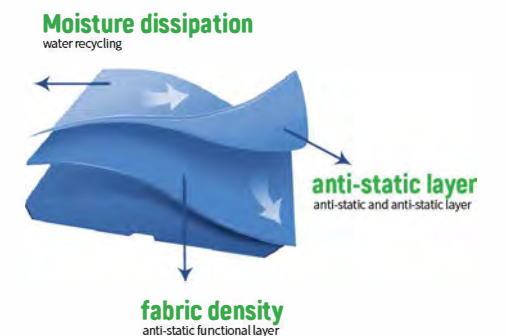

01 CLEANROOM CONSUMABLES

02 HUMAN PROTECTION

03 Electrostatic control

04 Environmental purification

Secondary category

A Cleanroom clothing

B Disposable protective clothing

C Cleanroom cap

D Cleanroom shoes

E Protective gloves

F Finger sleeve

G Shoe cover

01 CLEANROOM CONSUMABLES

02 HUMAN PROTECTION

03 Electrostatic control

04 Environmental purification

Secondary category

A Cleanroom clothing

B Disposable protective clothing

C Cleanroom cap

D Cleanroom shoes

E Protective gloves

F Finger sleeve

G Shoe cover

01 CLEANROOM CONSUMABLES

### Anti-static stand-up collar split suit

Model	Fabric	Properties	Main material	Uses
MSD-04-1	0.5 Stripe 100D	Dustproof, anti-static, pollutant isolation	Anti-static fabric	Class10,000 or more

- The surface is thin and smooth and the texture is clear. Not only does it have certain visual characteristics, but the fabric also has good wear resistance and wrinkle resistance, making it easy to wear and care for every day
- Split design makes it easier for the wearer to perform various operations and activities when the body is moving

### Anti-static lapel split suit

Model	Fabric	Properties	Main material	Uses
MSD-04	0.5 Stripe 100D	Dustproof, anti-static, pollutant isolation	Anti-static fabric	Class10,000 or more

- The surface is thin and smooth and the texture is clear. Not only does it have certain visual characteristics, but the fabric also has good wear resistance and wrinkle resistance, making it easy to wear and care for every day
- Split design makes it easier for the wearer to perform various operations and activities when the body is moving

02 HUMAN PROTECTION



Precision electronics industry  
ISO CLASS 7-9  
Anti-static

• Unisex • S-4XL  
White Blue

#### • Application scenarios:

• Mainly used in workshops with high anti-static and dustproof requirements

#### • Details display:

**01 Stand collar design**  
Stand collar design, reasonable cutting, durable, good upper body effect

**02 Side seam pockets**  
Convenient for storing mobile phones or dustfree notebooks, etc

**03 Elastic top strap**  
Fits the human body better and prevents pollutants from falling off

**04 Arm pocket**  
Arm pocket design, can hold writing pen or marker

**05 Cuffs**  
The cuffs are loose and tight to prevent dust from falling on the inner clothes.

**06 Chest loop design**  
Place the work number clip for easy identification

**07 Fine workmanship**  
Smooth and beautiful stitching

01 CLEANROOM CONSUMABLES

02 HUMAN PROTECTION



Precision electronics industry  
ISO CLASS 7-9  
Anti-static

• Unisex • S-4XL  
White Pink Blue

#### • Application scenarios:

• Mainly used in industries where static electricity requirements are not particularly strict, such as electronics, food, less sensitive work environments in the pharmaceutical industry

#### • Details display:

**01 Neckline design**  
Classic lapel design, reasonable cutting, durable, good effect on the body

**02 Fine workmanship**  
Smooth and beautiful stitching

**03 Cuffs**  
The cuffs are loose and tight to prevent dust from falling on the inner clothes.

**04 Side seam pockets**  
Convenient for storing mobile phones or dustfree notebooks, etc

**05 Chest loop design**  
Place the work number clip for easy identification

**06 Arm pocket**  
Arm pocket design, can hold writing pen or marker

**07 Elastic top strap**  
Fits the human body better and prevents pollutants from falling off

01 CLEANROOM CONSUMABLES

02 HUMAN PROTECTION

### Anti-static coat

Model	Fabric	Properties	Main material	Uses
MSD-05	0.5 Stripe 100D	Dustproof, anti-static, pollutant isolation	Anti-static fabric	Class10,000 or more

- Generally, it is a coat style with a loose design. It will not cause too much restraint on the body after wearing, does not hinder the normal activities of the human body, and is convenient for the wearer to perform various operations
- Usually with an open placket design with buttons or zippers, the process of putting on and taking off is simple and quick, which can improve work efficiency



• Unisex • S-4XL  
 White  Pink  Blue

#### • Application scenarios:

- Used in workshops where anti-static requirements are not too high and there are no special requirements for cleanliness

#### • Details display:

**01 Neckline design**  
Classic lapel design, reasonable cutting, durable, good effect on the body

**02 Buttons**  
Made of high-quality plastic, not easy to fall off, durable

**03 Cuffs**  
The cuffs are loose and tight to prevent dust from falling on the inner clothes.

**04 Side seam pockets**  
Convenient for storing mobile phones or dust-free notebooks, etc

**05 Chest loop design**  
Place the work number clip for easy identification

**06 Arm pocket**  
Arm pocket design, can hold writing pen or marker

**02 Fine workmanship**  
Smooth and beautiful stitching

01 CLEANROOM CONSUMABLES

02 HUMAN PROTECTION

### Split suit with pants

Model	Fabric	Properties	Main material	Uses
MSD-04-3Y	75D matte stretch yarn	dustproof, isolate pollutants	dustproof fabric	maintain the cleanliness of the environment

- Patchwork buried clip, round neck, neckline piping, cuffs and ankles 2cm elasticated, clothes hem rolled 2cm
- Elasticated waistband, three-fold hemming, 3cm elastic
- Won't absorb dust and particles in the air, effectively keeping the work area clean

#### • Application scenarios:

- Used in industries with high cleanliness requirements such as electronics, medicine, and food

#### • Details display:

**02 Arm pocket**  
Fashionable round neck design, simple and generous

**02 Cuff design**  
Elastic cuffs and hem design, no restraint, more convenient

**02 Exquisite sewing**  
High-quality sewing thread, smooth stitching

**02 Fabric**  
Breathability, barrier properties, moisture and heat resistance



• Unisex • S-4XL  
 White  Blue

### Split suit with pants

Model	Fabric	Properties	Main material	Uses
MSD-04-4Y	75D matte stretch yarn	dustproof, isolate pollutants	dustproof fabric	maintain the cleanliness of the environment

- Short sleeves including trousers, sewn with ordinary thread, patchwork embedded clips, round neck, neckline piping, cuffs and ankles, hem of clothes rolled 1cm
- Elasticated waistband, three-fold hemming, 2cm elasticated
- Won't absorb dust and particles in the air, and can effectively keep the work area clean

#### • Application scenarios:

- Used in industries with high cleanliness requirements such as electronics, medicine, and food

#### • Details display:

**01 Arm pocket**  
Fashionable round neck design, simple and generous

**02 Split design**  
Easy to put on and take off, elastic waist design

**03 Exquisite sewing**  
High-quality sewing thread, smooth stitching

**04 Fabric**  
Breathability, barrier properties, moisture and heat resistance



• Unisex • S-4XL  
 White  Blue

02 Electrostatic control

04 Environmental purification

Secondary category

A Cleanroom clothing

B Disposable protective clothing

C Cleanroom cap

D Cleanroom shoes

E Protective gloves

F Finger sleeve

G Shoe cover

03 Electrostatic control

04 Environmental purification

Secondary category

A Cleanroom clothing

B Disposable protective clothing

C Cleanroom cap

D Cleanroom shoes

E Protective gloves

F Finger sleeve

G Shoe cover

### PP Velcro Workwear

Model	Fabric	Properties	Main material	Uses
PNC-01	PP30g single collar Velcro	dustproof, isolate pollutants	PP	maintain the cleanliness of the environment

- Made of environmentally friendly and non-toxic PP material, safe and green
- It has a compact structure and can effectively block dust, debris, etc.
- Moreover, PP molecular structure is special, breathable and not stuffy, comfortable to wear, and works more efficiently

#### • Application scenarios:

- Used in electronics, medicine, food and other industries

#### • Details display:

<p><b>01 Neckline design</b></p> <p>Three-dimensional, beautiful and practical</p>	<p><b>02 Velcro</b></p> <p>Double-sided adhesive, not easy to fall off and easy to wear</p>
<p><b>03 Cuff design</b></p> <p>Fits the wrist, not tight or loose</p>	<p><b>04 PP fabric</b></p> <p>Thick and tear-resistant, water-repellent, oil-proof and breathable</p>



### PP Button Workwear

Model	Fabric	Properties	Main material	Uses
PNC-03	PP 30g single collar button model	dustproof, isolate pollutants	PP	maintain the cleanliness of the environment

- Made of environmentally friendly and non-toxic PP material, safe and green
- It has a compact structure and can effectively block dust, debris, etc.
- Moreover, PP molecular structure is special, breathable and not stuffy, comfortable to wear, and works more efficiently

#### • Application scenarios:

- Used in electronics, medicine, food and other industries

#### • Details display:

<p><b>01 Neckline design</b></p> <p>Three-dimensional, beautiful and practical</p>	<p><b>02 Buttons</b></p> <p>Easy to put on and take off, simple and elegant</p>
<p><b>03 Cuff design</b></p> <p>Fits the wrist, not tight or loose</p>	<p><b>04 PP fabric</b></p> <p>Thick and tear-resistant, water-repellent, oil-proof and breathable</p>



### PP Velcro Workwear (Knitted Sleeve)

Model	Fabric	Properties	Main material	Uses
PNC-02	PP30g single collar button model	dustproof, isolate pollutants	PP	maintain the cleanliness of the environment

- Made of environmentally friendly and non-toxic PP material, safe and green
- It has a compact structure and can effectively block dust, debris, etc.
- Moreover, PP molecular structure is special, breathable and not stuffy, comfortable to wear, and works more efficiently

#### • Application scenarios:

- Used in electronics, medicine, food and other industries

#### • Details display:

<p><b>01 Neckline design</b></p> <p>Three-dimensional, beautiful and practical</p>	<p><b>02 Velcro</b></p> <p>Double-sided adhesive, not easy to fall off and easy to wear</p>
<p><b>03 Cuff design</b></p> <p>knitted cuffs, fit the wrist, comfortable and not tight</p>	<p><b>04 PP fabric</b></p> <p>Thick and tear-resistant, water-repellent, oil-proof and breathable</p>



### SMS Knitted Collar Workwear

Model	Fabric	Properties	Main material	Uses
PNC-04	30g knitted collar button	dustproof, isolate pollutants	Non-woven fabrics	maintain the cleanliness of the environment

- Designed with thickened breathable fabric with reusable buttons
- It is composed of a spunbond layer and a meltblown layer. The outer layer is wear-resistant and scratch-resistant, and the middle layer effectively blocks pollutants. It has good breathability, making it dry and not stuffy to wear
- The collar is made of knitted material, soft and skin-friendly, fits the neck, has good elasticity

#### • Application scenarios:

- Used in semiconductor, new energy, food industry, etc

#### • Details display:

<p><b>02 Neckline design</b></p> <p>SMS extra thick knitted round neck, three-dimensional lapel, simple and stylish</p>	<p><b>02 Buttons</b></p> <p>Easy to put on and takeoff, simple and elegant</p>
<p><b>02 Cuff design</b></p> <p>Knitted cuffs fit the wrists comfortably without being tight</p>	<p><b>02 Pocket design</b></p> <p>Double side pockets for easy storage</p>



### SMS Button Workwear

Model	Fabric	Properties	Main material	Uses
PNC-05	40g single collar button model	dustproof, isolate pollutants	Non-woven fabrics	maintain the cleanliness of the environment

- Breathable and dustproof, not tight when worn for a long time, no washing and no maintenance, convenient, safe and hygienic
- Designed with thickened breathable fabric with reusable buttons
- Made of spunbond layer and meltblown layer, the outer layer is wear-resistant and scratch-resistant, and has good breathability, making it dry and not stuffy to wear

**Application scenarios:**

- Used in electronics, medicine, food and other industries

**Details display:**

<p><b>02 Neckline design</b></p> <p>Three-dimensional, beautiful and practical</p> 	<p><b>02 Buttons</b></p> <p>Easy to put on and takeoff, simple and elegant</p> 
<p><b>02 Cuff design</b></p> <p>Knitted cuffs fit the wrists comfortably without being tight</p> 	<p><b>02 Pocket design</b></p> <p>Double side pockets for easy storage</p> 



### Cleanroom Caps

Product name	Model	Size	Uses
Large/small work hat	MSD-06/MSD-06-1	One Size	Visit or general clean area

- Use in combination with a split suit and a coat to cover the head and hold the hair to prevent the fine dust generated on the head from falling
- Material: Anti-static fabric



Product name	Model	Size	Uses
Shawl hat	MSD-06-3	One Size	Visit or general clean area

- Use in combination with a split suit and a coat to cover the head and hold the hair to prevent the fine dust generated on the head from falling
- Material: Anti-static fabric



Product name	Model	Size	Uses
Nurse hat	MSD-06-2	One Size	Visit or general clean area

- Use in combination with a split suit and a coat to cover the head and hold the hair to prevent the fine dust generated on the head from falling
- Material: Anti-static fabric



Product name	Model	Size	Uses
Bowler hat	MSD-06-4	One Size	Visit or general clean area

- Use in combination with a split suit and a coat to cover the head and hold the hair to prevent the fine dust generated on the head from falling
- Material: 75D matte elastic yarn



### SMS Velcro Workwear

Model	Fabric	Properties	Main material	Uses
PNC-06	40g single collar button model	dustproof, isolate pollutants	Non-woven fabrics	maintain the cleanliness of the environment

- Breathable and dustproof, not tight when worn for a long time, no washing and no maintenance, convenient, safe and hygienic
- Designed with thickened breathable fabric with reusable buttons
- Made of spunbond layer and meltblown layer, the outer layer is wear-resistant and scratch-resistant, and has good breathability, making it dry and not stuffy to wear

**Application scenarios:**

- Used in electronics, medicine, food and other industries

**Details display:**

<p><b>02 Neckline design</b></p> <p>Three-dimensional, beautiful and practical</p> 	<p><b>02 Velcro</b></p> <p>Double-sided adhesive, not easy to fall off and easy to wear</p> 
<p><b>02 Cuff design</b></p> <p>Knitted cuffs fit the wrists comfortably without being tight</p> 	<p><b>02 Pocket design</b></p> <p>Double side pockets for easy storage</p> 



### Disposable protective cap

Product name	Model	Material	Color	Uses
Strip cap (doublerib)	DP-01	High quality non-woven fabric	Blue, White	New energy, biopharmaceuticals, semiconductors
Mesh cap	DP-02	polyester-cotton and mesh	White, Yellow, Dark Blue, Bright red, Light blue, Pink, Orange	Food industry
Doctor cap	DP-03	SMS nonwoven/PP	Blue	Biopharmaceuticals
Strip cap (single rib)	DP-04	high quality non-woven fabric	blue, white, light yellow	New energy, biopharmaceuticals, semiconductors

- The hat body is designed to fit the curve of the head and can tightly wrap the hair, effectively preventing hair from being exposed, preventing hair, dander, etc. from being mixed into the working environment, providing reliable protection for industries with high cleanliness requirements such as food processing, medical care, and electronic manufacturing. protection
- Good breathability, even if worn for a long time, it will not make the head feel stuffy, always keeping it fresh and comfortable
- The elastic design of the hat not only ensures the stability of wearing, but also does not cause pressure on the forehead. The user can move freely at work without any restraints



Anti-static shoes are protective shoes that can eliminate the accumulation of static electricity in human body and prevent electric shock below 250V. The principle is that the sole is manufactured by adopting dissipative materials such as PVC or PU foam materials and matching the anti-static ground, so that the static charge of the human body can be guided to the earth through the shoes, thereby eliminating the static electricity of the human body and inhibiting the dust generated by people walking in the clean room.

● **Myesde anti-static shoe size standard reference** ●

(Please buy samples to try on before bulk ordering)

Size/Standard [cm]								
36#	37#	38#	39#	40#	41#	42#	43#	44#
23.0	23.5	24.0	24.5	25.0	25.5	26.0	26.5	27.0

**Anti-static slippers**



<b>Product Name</b>	Toe Protector Slippers (SPU)
<b>Material</b>	High-quality SPU environmentally friendly material
<b>Volume resistance</b>	10 <sup>9</sup> Ω-10 <sup>10</sup> Ω
<b>Specifications</b>	23CM-28CM(36-46 yards, only double yards)
<b>Features</b>	Beautiful appearance, strong breathability, easy to wear, toe protection



<b>Product Name</b>	Round Logo Slippers (SPU)
<b>Material</b>	High-quality SPU environmentally friendly material
<b>Volume resistance</b>	10 <sup>9</sup> Ω-10 <sup>10</sup> Ω
<b>Specifications</b>	23CM-29CM(36-46 yards, only double yards)
<b>Features</b>	Beautiful appearance, easy to clean, strong breathability, easy to wear



<b>Product Name</b>	Cross Slippers (SPU)
<b>Material</b>	High-quality SPU environmentally friendly material
<b>Volume resistance</b>	10 <sup>9</sup> Ω-10 <sup>10</sup> Ω
<b>Specifications</b>	23CM-29CM(36-46 yards, only double yards)
<b>Features</b>	Beautiful appearance, easy to clean, strong breathability, easy to wear

**Anti-static shoes**



<b>Product Name</b>	Velcro canvas shoes
<b>Upper material</b>	Canvas, double-layer dense mesh
<b>Sole material</b>	PU/SPU/PVC optional
<b>Specifications</b>	22CM - 28CM (size 34 - size 46)
<b>Volume resistance</b>	10 <sup>9</sup> Ω-10 <sup>10</sup> Ω
<b>Color</b>	Blue, White optional



<b>Product Name</b>	Canvas four-hole shoes
<b>Upper material</b>	Canvas
<b>Sole material</b>	PU/SPU/PVC optional
<b>Specifications</b>	22CM - 28CM (size 34 - size 46)
<b>Volume resistance</b>	10 <sup>9</sup> Ω-10 <sup>10</sup> Ω
<b>Color</b>	Blue, White optional



<b>Product Name</b>	Canvas two-mesh shoes
<b>Upper material</b>	Canvas, double-layer dense mesh
<b>Sole material</b>	PU/SPU/PVC optional
<b>Specifications</b>	22CM - 28CM (size 34 - size 46)
<b>Volume resistance</b>	10 <sup>9</sup> Ω-10 <sup>10</sup> Ω
<b>Color</b>	Blue, White optional



<b>Product Name</b>	Canvas cotton mid-shoes
<b>Upper material</b>	Canvas
<b>Sole material</b>	PU/SPU/PVC optional
<b>Specifications</b>	22CM - 28CM (size 34 - size 46)
<b>Volume resistance</b>	10 <sup>9</sup> Ω-10 <sup>10</sup> Ω
<b>Features</b>	Beautiful appearance, generous, thickened lamb wool, strong warmth retention



<b>Product Name</b>	Leather four-hole shoes
<b>Upper material</b>	PVC/PU
<b>Sole material</b>	PU/SPU/PVC optional
<b>Specifications</b>	22CM - 28CM (size 34 - size 46)
<b>Volume resistance</b>	10 <sup>9</sup> Ω-10 <sup>10</sup> Ω
<b>Features</b>	Breathable and comfortable, beautiful appearance, enorousstrong warmth retention



<b>Product Name</b>	Striped canvas mid-shoes
<b>Upper material</b>	Striped canvas / solid canvas / PU/PVC
<b>Sole material</b>	PU/SPU/PVC optional
<b>Specifications</b>	22CM - 28CM (size 34 - size 46)
<b>Volume resistance</b>	10 <sup>9</sup> Ω-10 <sup>10</sup> Ω
<b>Features</b>	Blue and white optional

**Anti-static cleanroom shoes**



<b>Product Name</b>	Anti-static safety sandals
<b>Upper material</b>	PU / microfiber optional
<b>Toe cap material</b>	Steel toe cap / resin optional
<b>Specifications</b>	22.5CM - 28CM (size 35 - size 46)
<b>Volume resistance</b>	10 <sup>9</sup> Ω-10 <sup>10</sup> Ω
<b>Features</b>	Anti-smashing, breathable, anti-magnetic resin toe cap is optional if anti-magnetic is required
<b>Remarks</b>	Safety shoes can all be made into puncture-proof soles



<b>Product Name</b>	Medium towel safety shoes
<b>Upper material</b>	Upper punching, PU/microfiber optional
<b>Toe cap material</b>	steel head/resin optional
<b>Specifications</b>	22.5CM - 28CM (size 36 - size 46)
<b>Volume resistance</b>	10 <sup>9</sup> Ω-10 <sup>10</sup> Ω
<b>Features</b>	Anti-smashing, breathable, anti-magnetic resin toe cap is optional if anti-magnetic is required
<b>Remarks</b>	Safety shoes can all be made into puncture-proof soles



<b>Product Name</b>	Medium towel safety shoes
<b>Upper material</b>	PU/Microfiber Optional
<b>Toe cap material</b>	steel head/resin optional
<b>Specifications</b>	23CM - 28CM (size 36 - size 46)
<b>Volume resistance</b>	10 <sup>9</sup> Ω-10 <sup>10</sup> Ω
<b>Features</b>	Anti-smashing, breathable, anti-magnetic resin toe cap is optional if anti-magnetic is required
<b>Remarks</b>	Safety shoes can all be made into puncture-proof soles

**Anti-static high boots**



<b>Product Name</b>	Leather open net boots
<b>Upper material</b>	PVC/PU, double layer dense grid
<b>Sole material</b>	PU/SPU/PVC optional
<b>Specifications</b>	22CM - 28CM (size 34 - size 46)
<b>Volume resistance</b>	10 <sup>9</sup> Ω-10 <sup>10</sup> Ω
<b>Remarks</b>	The color of the long tube can be customized according to customer's needs



<b>Product Name</b>	Deep mouth boots
<b>Upper material</b>	PVC/PU
<b>Sole material</b>	PU/SPU/PVC optional
<b>Specifications</b>	22CM - 28CM (size 34 - size 46)
<b>Volume resistance</b>	10 <sup>9</sup> Ω-10 <sup>10</sup> Ω
<b>Remarks</b>	The color of the long tube can be customized according to customer's needs



<b>Product Name</b>	Long tube safety shoes (PU)
<b>Upper material</b>	PU/Microfiber Optional
<b>Toe cap material</b>	steel head/resin optional
<b>Specifications</b>	23CM - 28CM (size 36 - size 46)
<b>Volume resistance</b>	10 <sup>9</sup> Ω-10 <sup>10</sup> Ω
<b>Features</b>	Anti-smashing, breathable, anti-magnetic resin toe cap is optional if anti-magnetic is required
<b>Remarks</b>	It can be used as puncture proof soles, and the color of the long tube can be customized



<b>Product Name</b>	Shallow mouth boots
<b>Upper material</b>	PVC/PU
<b>Sole material</b>	PU/SPU/PVC optional
<b>Specifications</b>	22CM - 28CM (size 34 - size 46)
<b>Volume resistance</b>	10 <sup>9</sup> Ω-10 <sup>10</sup> Ω
<b>Features</b>	Shoe barrel composite foam is comfortable and warm, color can be customized



<b>Product Name</b>	Canvas boots
<b>Upper material</b>	Canvas
<b>Sole material</b>	PU/SPU/PVC optional
<b>Specifications</b>	22CM - 28CM (size 36 - size 46)
<b>Volume resistance</b>	10 <sup>9</sup> Ω-10 <sup>10</sup> Ω
<b>Features</b>	Beautiful appearance, easy to clean, strong breathability, convenient to wear
<b>Remarks</b>	The color of the long tube can be customized according to customer's needs



<b>Product Name</b>	Long safety shoes (upper punching)
<b>Upper material</b>	PU/Microfiber Optional
<b>Toe cap material</b>	steel head/resin optional
<b>Specifications</b>	23CM - 28CM (size 36 - size 46)
<b>Volume resistance</b>	10 <sup>9</sup> Ω-10 <sup>10</sup> Ω
<b>Features</b>	Anti-smashing, breathable, anti-magnetic resin toe cap is optional if anti-magnetic is required
<b>Remarks</b>	Safety shoes can all be made into puncture-proof soles

**Nitrile gloves (powder-free)**

Model	Specification	Package
MNW09-002	9 inch white finger hemp S/M/L/XL	50 pairs/pack 10 packs/box
MNB09-002	9 inch blue finger hemp S/M/L/XL	50 pairs/pack 10 packs/box
MNW12-002	12 inch white finger hemp S/M/L/XL	50 pairs/pack 10 packs/box
MNB12-002	12 inch blue finger hemp S/M/L/XL	50 pairs/pack 10 packs/box

• Tear resistance, acid and alkali resistance, hypoallergenic, high cleanliness, acid and alkali resistance, grease, fuel oil and various solvents

**Application scenarios:**

• Civil industries such as semiconductor industry, electronics industry, assembly, food processing, home gardening, kitchen cleaning, cleaning labor insurance, etc.

- RoHS Report
- Halogen Report
- Silicone oil test report
- Ion test report
- Ingredient Report
- Metal test report



- High-quality material
- Safe and skin-friendly
- puncture-resistant

**Nitrile Gloves (Boxed)**

Model	Specification	Package
MNB09-003	9 Inch Blue S/M/L/XL	50 pairs/pack 10 packs/box

• Good oil resistance, wear resistance, heat resistance, tear resistance, acid and alkali resistance, hypoallergenic, acid and alkali resistance, grease, fuel oil and various solvents  
 • The pockmark surface effect can easily grasp smooth objects and has good puncture resistance, giving it good puncture resistance, no allergic reaction to human skin, non toxic, harmless, strong and durable, good adhesion

**Application scenarios:**

• Civilian industries such as assembly, food processing, home gardening, kitchen cleaning, cleaning and labor insurance

- RoHS Report
- Halogen Report
- Silicone oil test report
- Ion test report
- Ingredient Report
- Metal test report



- Anti-slip
- wear-resistant
- oil-resistant, stretch-resistant

**Halogen-free nitrile gloves**

Model	Specification	Package
MHF12-001	12 inch white finger hemp S/M/L	50 pairs/pack 10 packs/box

• sulfur element & chlorine element content below 900ppm, effectively controlling metal corrosion, point crystallization and other defects, and improving the yield of chip products  
 • Newly improved nitrile rubber formula, good elasticity, wear resistance and puncture resistance, and comfort, fingertip pockmark design improves anti-slip performance; Curled hem at wrist mouth, easy to wear; Fits hand shape, sensitive to touch  
 • Contains no latex protein, eliminates allergic reactions caused by natural latex, has the ability to protect against a variety of chemicals, is non toxic and harmless

**Application scenarios:**

• Semiconductor industry, electronics industry, biopharmaceuticals, etc.

- RoHS Report
- Halogen Report
- Silicone oil test report
- Anti-Static Report
- Cleanliness R report



- Chemical resistant
- high elasticity and softness
- tensile strength

**Nitrile gloves for batteries**

Model	Specification	Package
MHS09 - 001	9 inch white finger hemp S/M/L	50 pairs/pack 10 packs/box

• Sulfur element & chlorine element content below 900ppm, can be placed on the cell for more than 72 hours without oxidation reaction  
 • Newly improved nitrile rubber formula, good elasticity, wear resistance and puncture resistance, and comfort  
 • Easy to wear; Fits hand shape, sensitive to touch, has the ability to protect against a variety of chemicals, is non toxic and harmless

**Application scenarios:**

• Worn by personnel in semiconductor factories, precision electronics, plastic molds, ink printing industries, etc., instrument assembly, product inspection, motherboard production, etc.

- RoHS Report
- Halogen Report
- Silicone oil test report
- Anti-Static Report
- Latex Composition Testing
- Cleanliness R report



- Sulfur free and low-chlorine
- no fingerprints
- non-slip and wear resistant

**Nitrile Gloves (Class 10)**

Model	Specification	Package
MRF12 - 001	12 Inch Translucent S/M/L	50 pairs/pack 10 packs/box

• Cleanliness can reach Class 10, low amount of particulate matter, no fingerprints  
 • Good oil resistance, wear resistance, heat resistance, high strength, high elasticity  
 • Protein-free, no allergic reaction to human skin  
 • Non toxic, harmless, durable, good adhesion, nitrile gloves can effectively prevent organic solvents

**Application scenarios:**

• Mainly used in cleanroom workshops in electronics, semiconductor and other industries

- RoHS Report
- Halogen Report
- Silicone oil test report
- Anti-Static Report
- Cleanliness R report



- Powder-free surface
- oil-resistant
- stretch-resistant

**Nitrile Gloves (Class 100)**

Model	Specification	Package
MNW09 - 004	9 inch white finger hemp S/M/L/XL	50 pairs/pack 10 packs/box
MNW12 - 004	9 inch white finger hemp S/M/L/XL	50 pairs/pack 10 packs/box

• Good oil resistance, wear resistance and heat resistance, high strength, high elasticity, no protein, no allergic reaction to human skin  
 • Non toxic, harmless, strong and durable, nitrile gloves can effectively prevent organic solvents

**Application scenarios:**

• Mainly used in electronics factories, medical examinations, chemicals, glass products, scientific research and other industries, especially suitable for 100-Class high-clean production environments

- RoHS Report
- Halogen Report
- Silicone oil test report
- Ion test report
- Ingredient Report
- Metal test report
- Anti-Static Report
- Cleanliness R report



- Anti-slip and wear resistant
- Powder-free
- Tensile-resistant

**Nitrile Gloves (Class1000)**

Model	Specification	Package
MNW09-005	9 inch white finger hemp S/M/L/XL	50 pairs/pack 10 packs/box
MNB09-005	9 inch blue finger hemp S/M/L/XL	50 pairs/pack 10 packs/box
MNW12-005	12 inch white finger hemp S/M/L/XL	50 pairs/pack 10 packs/box
MNB12-005	12 inch blue finger hemp S/M/L/XL	50 pairs/pack 10 packs/box

• Good oil resistance, wear resistance, heat resistance, high strength, high elasticity, effective anti-organic solvents, contains no protein, no allergic reaction to human skin, non toxic

**Application scenarios:**

• Mainly used in electronics factories, medical examinations, food industry, chemical industry, aquaculture industry, glass products and scientific research industries

- RoHS Report
- Halogen Report
- Silicone Anti-Static report
- Ion test report
- Ingredient Report
- Metal test report
- Anti-Static Report
- Cleanliness R report



- Powder free surface
- high elasticity and wear resistance

No matter where you are, you can enjoy the global high-quality goods and services provided by Myesde

### Latex gloves (bagged)

Model	Specification	Package
ML09-001	9 inch S/M/L/XL	50 pairs/pack 10 packs/box
ML09-002	9 inch S/M/L/XL	50 pairs/pack 10 packs/box
ML12-001	12 inch S/M/L/XL	50 pairs/pack 10 packs/box
ML12-002	12 inches 6.0 g/6.5g/7.5g/8.0g	50 pairs/pack 4 packs/box

• It is wear-resistant and puncture-resistant, not easy to break, and has good elasticity. Unique fingertip texture design to enhance grip and effectively prevent slippage. patented design without palm print on glossy surface, uniform dipping, enhanced protection. The pockmark effect can easily grip smooth objects

#### Application scenarios:

• Mainly used in semiconductors, LCD panels, optical products, precision electronics, laboratories, etc.

[RoHS Report](#)
[Silicone test report](#)
[Anti-Static Report](#)
[Latex Composition Testing](#)



- Flour-free hemp noodles
- High elasticity and wear resistance
- Not easy to break



### PU wear-resistant low-ion gloves

Model	Specification	Package
PU-001	white L size	25 pairs/pack 10 packs/box

- Not easy to allergy, resistant to weak acid and alkali, low ion content
- Can be used with disposable nitrile gloves for double protection
- Wear resistance, not easy to break

#### Application scenarios:

• Mainly used in 100-Class workshops, semiconductors, wafer electronics factories and other industries

[RoHS Report](#)
[Cleanliness Report](#)



- Not easy to pilling
- cleanroom and breathable
- Weak acid and alkali resistance



### Anti-static PVC gloves

Model	Specification	Package
MAS09-001	9 Inch S/M/L	50 pairs/pack 10 packs/box

- Stable anti-static effect  $1 \times 10^6 \Omega \sim 1 \times 10^9 \Omega$
- It can prevent static electricity from damaging electronic components, delay their aging, and improve the reliability and life of electronic products
- High-quality PVC gloves with super toughness and latex-free protein to effectively prevent allergies
- Fits both hands, enhances the feel, and brings a flexible operation experience

#### Application scenarios:

• Semiconductor industry, electronics industry, biopharmaceuticals, etc.

[RoHS Report](#)
[Halogen Report](#)
[Silicone test report](#)
[Anti-Static Report](#)



- Anti-penetration
- Good sealing
- Not easy to break



### PU anti-static gloves

Model	Specification	Package
MPUL-001	S/M/L	1000 Pairs/Box

- Made of special PU materials and technology
- No oxidation, no corrosion, no pollution to metal electronic components such as gold, silver and copper
- Surface resistance  $1 \times 10^5 \Omega \sim 1 \times 10^{11} \Omega$ , effectively preventing the accumulation of static electricity and avoiding damage to electronic components, equipment, etc. due to electrostatic discharge, suitable for use in environments sensitive to static electricity

#### Application scenarios:

• Mainly used in cleanroom workshops in electronics, semiconductor and other industries

[RoHS Report](#)
[Anti-Static Report](#)



- Anti-slip and wear
- Conductive fiber
- Not easy to break



### Disposable PVC gloves (bagged)

Model	Specification	Package
MP09-001	9 inch S/M/L/XL	50 pairs/pack 10 packs/box
MP12-001	12 inch S/M/L/XL	50 pairs/pack 10 packs/box

- High-quality polyvinyl chloride material, non-toxic, non-microbial, no impurities, no penetration, vacuum cleanroom encapsulation, low dust volume, ensured cleanliness
- Universal for left and right hands, curled wrist, easy to wear, strong and durable, no skin irritation or allergy
- Resistance to weak acids and alkalis, low ion content, flexibility, good touch, lightweight, flexible operation

#### Application scenarios:

• Semiconductor industry, electronics industry, assembly, food processing, hospital or clinic departments, etc.

[RoHS Report](#)
[Halogen Report](#)
[Silicone test report](#)
[Ieo test report](#)



- Anti-penetration
- Powder-free glossy surface
- Not easy to break



### Point plastic anti-static gloves

Model	Specification	Package
MPP-001	S/M/L	1000 Pairs/Box

- An anti-static glove that enhances performance by attaching plastic particles to the glove surface through a special process
- The evenly distributed plastic particles on the surface of the glove increase the friction between the glove and the surface of the object, allowing it to hold items more firmly and are less likely to slip off
- Surface resistance  $1 \times 10^5 \Omega \sim 1 \times 10^{11} \Omega$  to prevent damage caused by static electricity accumulation

#### Application scenarios:

• Mainly used in cleanroom workshops in electronics, semiconductor and other industries

[RoHS Report](#)
[Anti-Static Report](#)



- Not easy to degumming
- Particle homogeneity
- Non-slip and durable



### Disposable PVC gloves (boxed)

Model	Specification	Package
MP09-002	9 Inch S/M/L	50 pairs/pack 10 packs/box

- PVC gloves are glove products with polyvinyl chloride as the main raw material
- Strong and durable, ergonomically designed, comfortable to wear, waterproof, oil-proof and airtight, and the sealing material is impermeable
- Fully protect hands from erosion, touch screen design, sliding screen without obstruction
- Flexible and convenient operation of the mobile phone, avoiding frequent wearing and taking off

#### Application scenarios:

• Experimental analysis, daily cleaning, garden agriculture, beauty salons, garden production, pet cleaning, hospitals, clinic departments, hotel services, etc.

[RoHS Report](#)
[Halogen Report](#)
[Silicone test report](#)
[Ieo test report](#)



- Powder-free glossy surface
- Not easy to break
- Waterproof and oil resistant



### Double-sided anti-static gloves

Model	Specification	Package
MDA-001	S/M/L	1000 Pairs/Box

- Has good elasticity and anti-static properties to avoid damage to the product caused by static electricity
- No oxidation, no corrosion, no pollution to metal electronic components such as gold, silver and copper
- Surface resistance  $1 \times 10^5 \Omega \sim 1 \times 10^{11} \Omega$  to prevent damage caused by static electricity accumulation

#### Application scenarios:

• Mainly used in cleanroom workshops in electronics, semiconductor and other industries

[RoHS Report](#)
[Anti-Static Report](#)



- Anti-slip and wear
- Conductive fiber
- Not easy to break



- A Cleanroom clothing
- B Disposable protective clothing
- C Cleanroom cap
- D Cleanroom shoes
- E Protective gloves
- F Finger sleeve
- G Shoe cover

- A Cleanroom clothing
- B Disposable protective clothing
- C Cleanroom cap
- D Cleanroom shoes
- E Protective gloves
- F Finger sleeve
- G Shoe cover

### Knitted gloves

Model	Specification	Package
MKG - 001	S/M/L/XL	10 pairs/pack 300 pairs/carton
MKGF - 001	S/M/L/XL	10 pairs/pack 300 pairs/carton
MKG P - 001	S/M/L/XL	10 pairs/pack 300 pairs/carton
MKGH - 001	S/M/L	10 pairs/pack 300 pairs/carton

• Good breathability, stretchability, moisture absorption, breathability and comfort, less fiber drop, low dust emission, good anti-slip and wear resistance

#### Application scenarios:

• Mainly used for production inspection stations in precision instrument assembly, electronic circuit and other industries

RoHS Report



RoHS

### Anti-static gloves

Model	Specification	Package
MCG - 001	S/M/L/XL	10 pairs/pack 300 pairs/carton
MCGF - 001	S/M/L/XL	10 pairs/pack 300 pairs/carton
MCGP - 001	S/M/L/XL	10 pairs/pack 300 pairs/carton

• Good air permeability, good stretchability, good moisture absorption, less fiber drop, low dust generation, and good anti-slip and wear resistance

• It has a variety of excellent properties such as anti-static, oil-proof, sweat absorbing, cleanroom, high temperature resistance, etc., long service life, and can be reused

#### Application scenarios:

• Mainly used in the electronics industry, semiconductors, daily life, etc.

RoHS Report



RoHS

### Hot-melt edge knitted gloves

Model	Specification	Package
KGW - 001	S/M/L	10 pairs/pack 300 pairs/carton
KGW - 002	S/M/L	10 pairs/pack 300 pairs/carton
KGW - 003	S/M/L	10 pairs/pack 300 pairs/carton

• It has good breathability, is not easy to produce dust, fits and is not easy to fall, and is comfortable to wear. The material is nylon/PU/carbon fiber

• Good hygroscopicity, the fiber can absorb moisture in the air, soft but not stiff when worn by personnel

#### Application scenarios:

• Worn by personnel in semiconductor factories, precision electronics, plastic molds, ink printing industries, etc., instrument assembly, product inspection, motherboard production, etc.

RoHS Report, Latex composition test



RoHS

### Latex gloves (bagged)

Model	Color	Package
MFLY - 001	Beige Finger Sleeve	S/M/L
MFLW - 001	White Finger Sleeve	M/L
MFLP - 001	Pink Finger Sleeve	M
MFLB - 001	Black Finger Sleeve	S/M
MFLQ - 001	Cut Out Finger Sleeve	S/M
MFLO - 001	Anti-Slip Finger Sleeve	M/L
MFNB - 001	Blue Finger Sleeve	M

Method	Halogen	Cleanliness	Antistatic Effect	Lifespan
Machine rolled	chlorine free	low	good	long
Hand Roll	Chlorine Wash	High	Normal	Short

• Latex finger covers are made of natural latex through special process  
 • Available in cut out models, sulfur free models, anti-slip models, and anti-static models  
 • Powder free, low dust, halogen-free and sulfur free, frosted and bumped points can increase the anti-slip effect  
 • Anti-static value  $1 * 10^5 \Omega \sim 1 * 10^{11} \Omega$   
 • Divided into latex finger covers and nitrile finger covers according to different materials  
 • According to the color, there are regular pink, black, white, orange  
 • Depending on the texture of the finger sleeve, there are usually frosted and glossy surfaces  
 • According to different processes, it is divided into machine roll, hand roll and incision  
 • According to different special functions, it is divided into anti-static, halogen-free and sulfur free

#### Application scenarios:

• Mainly used in semiconductor workshops, clean rooms, purification workshops and other places, as well as high tech production environments such as export food processing, optoelectronic products, computer accessories, LCD, and electronic components, as well as human fingertip pollutant control scenarios

RoHS Report, Halogen Report, Silicone test report, Anti-Static Report, Cleanliness Report



### Anti-static shoes cover

Model	Specification	Package
ASC-001	35g, regular, blue	100 pairs/pack, 2000 pairs/box (20 packs/box)

• Made of special anti-static material, it can quickly guide the human body to generate static charge to avoid the accumulation of static electricity  
 • Can effectively block sole dust, hair, debris, etc. from entering specific areas, and keep clean spaces clean  
 • Usually designed with elasticated openings or shoe cover openings that are flexible for quick putting on and off, saving time  
 • The texture is light and thin, which will not put too much burden on the feet when wearing, and allows you to move freely

#### Application scenarios:

• Mainly used in agricultural films, shoemaking, tanning, mattresses, quilts, decoration, chemicals, printing, automobiles and other industries  
 • Used in the medical and health industry, food processing, electronics, precision instrument manufacturing, pharmaceutical industry

### Disposable shoe covers

Model	Specification	Package
MSC-001	2.5 g, regular, blue	100 pairs/pack, 20 packs/box
MSC-002	black conductive, fabric 35g	100 pairs/pack, 20 packs/box
MSC-003	woven extended shoe cover, 49 * 14cm, blue	100 pairs/pack, 20 packs/box
MSC-004	non-woven shoe cover, thickened, 35g, blue	100 pairs/pack, 20 packs/box

• Non-woven shoe covers are made of new environmentally friendly materials, this non-woven printed shoe cover is non-slip, practical and beautiful  
 • Highly elastic rubber band makes shoe covers more comfortable to wear

#### Application scenarios:

• Mainly used in agricultural films, shoemaking, tanning, mattresses, quilts, decoration, chemicals, printing, automobiles and other industries.  
 • Also used in medical and health, food processing, electronics, precision instrument manufacturing, pharmaceutical and other industries



### Secondary category

A Cleanroom clothing

B Disposable protective clothing

C Cleanroom cap

D Cleanroom shoes

E Protective gloves

F Finger sleeve

G Shoe cover

### Secondary category

A Cleanroom clothing

B Disposable protective clothing

C Cleanroom cap

D Cleanroom shoes

E Protective gloves

F Finger sleeve

G Shoe cover

# ELECTROSTATIC CONTROL

- Ion blower series
- Ion air nozzle series
- Anti-static product series
- Anti-static chair series

Outstanding electrostatic performance



To prevent micro-contamination and empower high technology.

## ESD digital monitoring system

Provide practical guarantee for qualified ESD/EOS production environment!

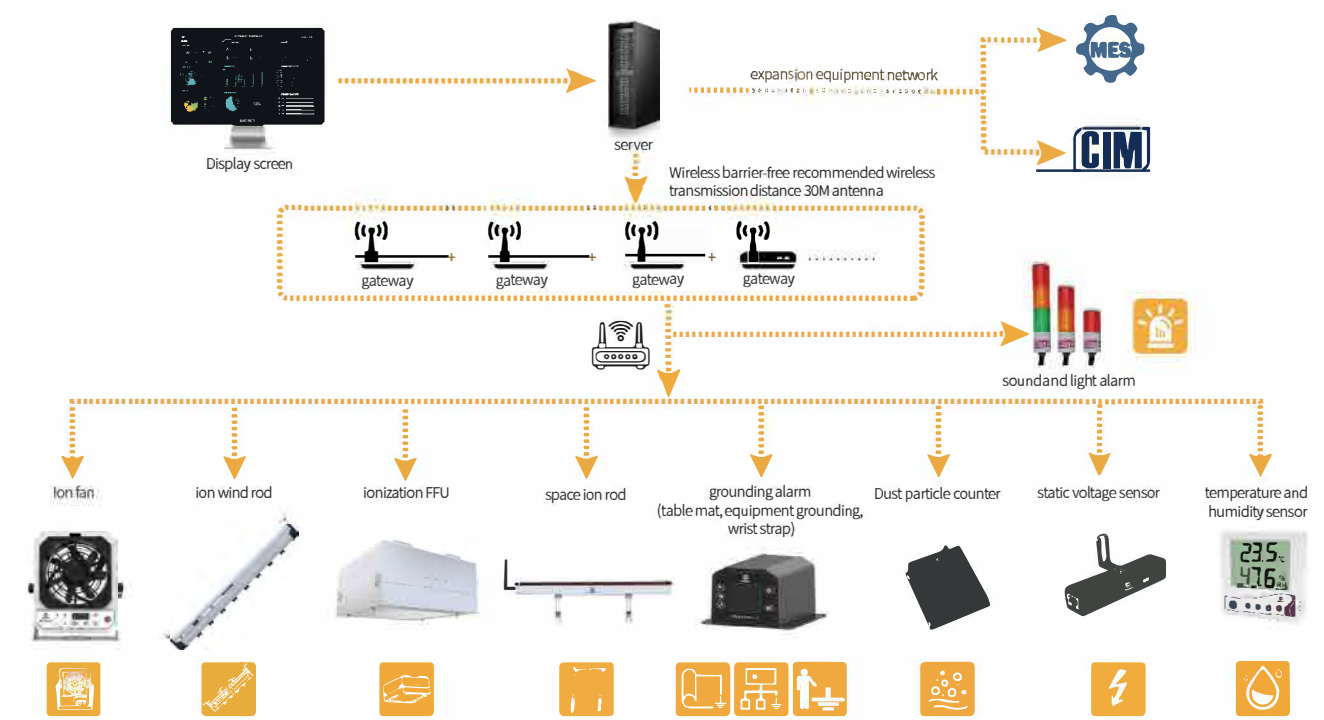

### From manual operation to full automation

Each equipment works together to achieve comprehensive environmental monitoring and effective control, improve production efficiency and quality, and ensure safety

#### • System module

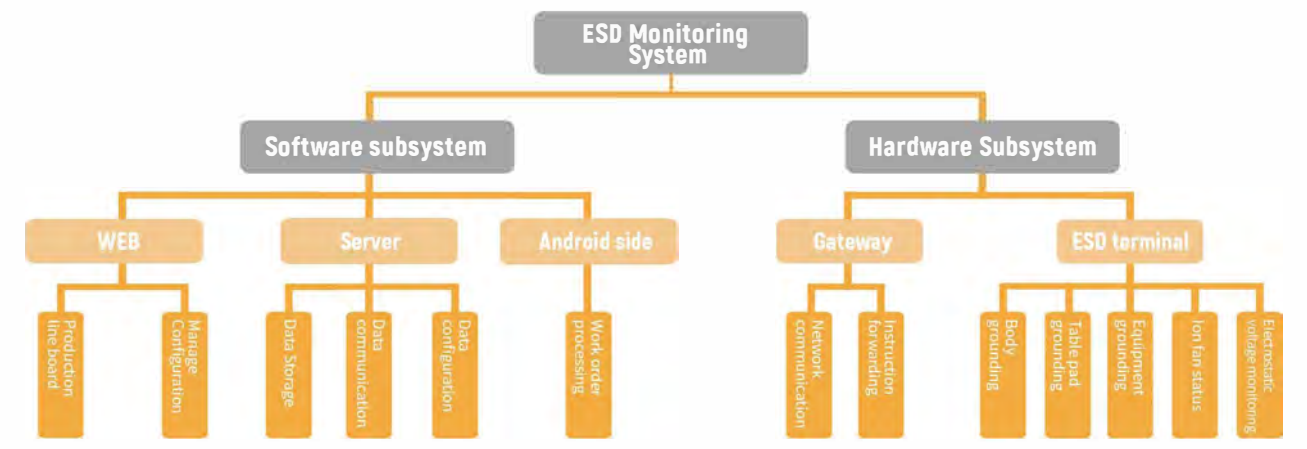

- 01 CLEANROOM CONSUMABLES
- 02 Human protection
- 03 ELECTROSTATIC CONTROL**
- 04 Environmental purification
- Secondary category
- A ESD digital monitoring system
- B Ion blower
- C Static eliminator use case
- D Ion nozzle
- E Tester
- F Anti-static products
- G Antistatic table mats, floor mats
- H Anti-static door curtains
- I Antistatic turnover box
- J Anti-static tweezers
- K Anti-static chair

01 CLEANROOM CONSUMABLES

02 Human protection

03 ELECTROSTATIC CONTROL

04 Environmental purification

Secondary category

A ESD digital monitoring system

B Ion blower

C Static eliminator use case

D Ion nozzle

E Tester

F Anti-static products

G Anti-static table mats, floor mats

H Anti-static door curtains

I Anti-static turnover box

J Antistatic tweezers

K Antistatic chair

01 CLEANROOM CONSUMABLES

02 Human protection

03 ELECTROSTATIC CONTROL

04 Environmental purification

Secondary category

A ESD digital monitoring system

B Ion blower

C Static eliminator use case

D Ion nozzle

E Tester

F Anti-static products

G Anti-static table mats, floor mats

H Anti-static door curtains

I Anti-static turnover box

J Antistatic tweezers

K Antistatic chair

## High frequency ion blower (KF-21AW-6P)

Distance	static removal time (positive/negative)	ion balance (positive/negative)
300mm	1.5s/1.8s	0±10V
600mm	2.5s/3.0s	0±15V
900mm	3.5s/4.6s	0±20V

1. Use TREK-156A static elimination flat panel detector 2. The static elimination time refers to the decay time from +1000V to +100V when the rear windshield is not equipped with a filter and the air volume is at maximum.

- It has the function of automatically cleaning the discharge needle, and the fan is in reverse state to protect the cleanliness of the product and reduce the frequency of manual cleaning and maintenance
- With wireless network monitoring function, real-time monitoring through wireless receiver and transmitter
- According to the workshop environment, the cleaning time of the discharge needle can be displayed through the LED digital tube, which is adjustable from 0 to 999 hours
- Automatic ion balance system, ion balance can reach: within 0 ± 10V
- With the whole machine locking function and abnormal alarm function

CE certification | SGS Report | Tungsten needle test report | Anti-Static Report



SGS  
CE  
Anti-static

### Product Features

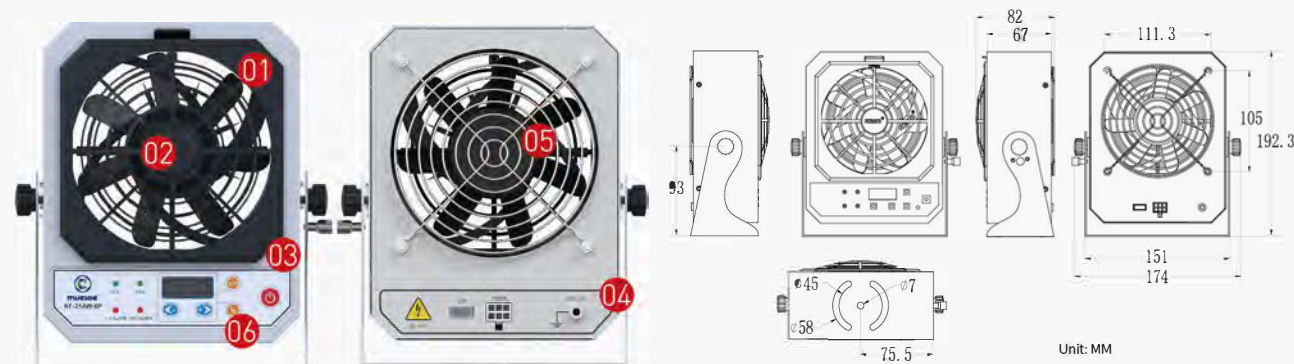

#### 01 Front windshield

A linear grid windshield is adopted to enhance the static electricity removal effect. It can be flexibly disassembled for easy maintenance (can be purchased separately as an accessory)

#### 02 Discharge needle

The component is easy to disassemble, easy to replace and maintain. Cleaning and maintenance can be carried out outside the workplace to avoid secondary pollution (can be purchased separately as an accessory)

#### 03 Housing

#### 04 Rear label

#### 05 Rear windshield

#### 06 Operation panel and function buttons

- Power switch button
  - 1) After the power is turned on, press the power switch button to turn on the machine.
  - 2) During normal operation, it has a memory function after power is cut off, and there is no need to press the power switch button to turn on after power is turned on again.
- FAN Function Indicator
- High Voltage Normal Operation Indicator
- High voltage abnormal operation indicator lamp
- Fan abnormal operation indicator

- F-01 Fan wind speed is adjustable in seven gears F-01 ~ F-07
- H999 Cleaning time setting adjustment H000 ~ H999 (unit hour)
- LOC+ The whole machine key function is locked
- PASS Unlock key function of the whole machine
- HASH Discharge needle cleaning
- SET wind speed, cleaning setting conversion button
- Manual cleaning button
 

After pressing, the whole machine reverses and stops working, which is used to manually clean the discharge needle
- Air volume increment button of 1-7 gears
 

0 ~ 999 hours when cleaning time is set
- Air volume 1-7 decrease button
 

When the cleaning time is set, the decrease button is 0 ~ 999 hours

Press "+" and "-" for more than 5 seconds at the same time, and the whole machine will automatically lock

### Technical parameters

Category	Parameters	Category	Parameters
Input voltage	DC24V	Wind volume	2.44-5.1m³/min
Ion balance	Automatic ion balance system 0±10V	Ozone concentration	≤0.015ppm (distance 50mm)
Cleaning timer setting time	Set within the range of 0-999 hours	Operating environment temperature and humidity	0-40°C 15-75%RH (no condensation, no water drop condensation)
Mode of voltage application	AC mode/±2200V	Power consumption	≤17W
Weight	1.5kg (including bracket)	Noise	≤68db

## High frequency ion blower (KF-40AR)

Distance	static removal time (positive/negative)	ion balance (positive/negative)
300mm	1.0s/1.5s	0±10V
600mm	2.0s/3.0s	0±15V
900mm	3.5s/4.5s	0±20V

1. Use TREK156A static elimination flat panel detector 2. The static elimination time refers to the decay time from +1000V to +100V when the rear windshield is not equipped with a filter and the air volume is at maximum.

- Automatic cleaning of discharge needle, fan reversal, reduce manual cleaning frequency, and prevent foreign matter from contaminating the product
- Equipped with automatic ion balance system, the ion balance is accurately controlled within 0 ± 10V
- According to the workshop environment, the LED digital tube can display and adjust the cleaning discharge needle time (0-999 hours)
- An ion blower with appropriate length can be selected according to the workbench and product size
- Has whole machine locking function and wireless monitoring function, and supports LoRa mode

CE certification | SGS Report | Tungsten needle test report | Anti-Static Report



Hot Selling | CE | SGS | Anti-static

### Product Features

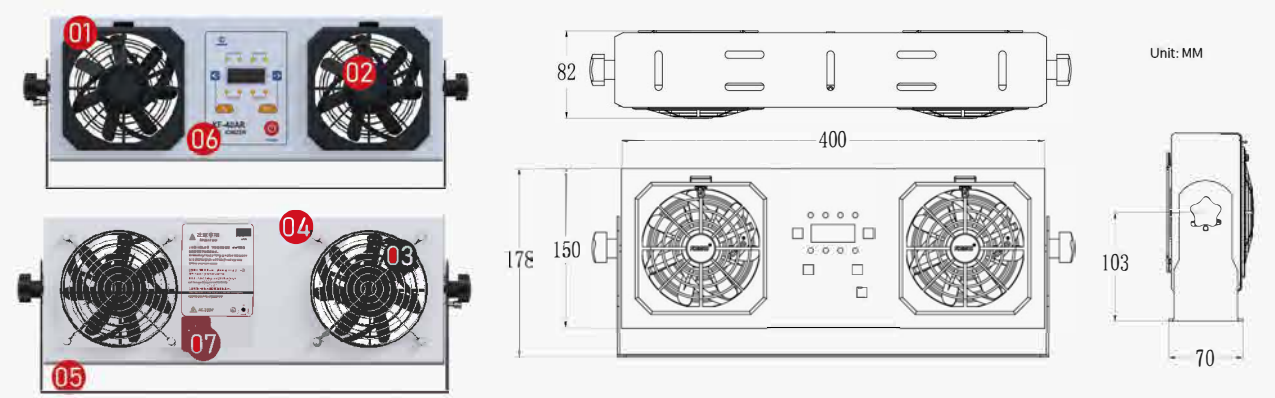

#### 01 Front windshield

The front windshield can be freely disassembled, and after disassembly, the fan will automatically cut off the power. Built-in automatic cleaning discharge needle structure, which is maintenance-free. The brush made of special materials make cleaning more thorough. (Accessory can be purchased separately)

#### 02 Discharge needle

The discharge needle holder can be freely disassembled, making maintenance and replacement easy. It uses tungsten alloy discharge needles with a tungsten content of 99.9%, and each needle generates both positive and negative ions, achieving an automatic ion balance system (Accessory can be purchased separately)

#### 03 Rear windshield

Metal window mesh (120\*120mm)  
Filter window (accessory, can be purchased separately)

#### 04 Exterior shell

The shell is made of spray-coated process (standard white powder)

#### 05 Mounting bracket

#### 06 Operation panel and function buttons

- Power switch button
  - 1) Press the power switch after power on.
  - 2) During normal operation, there is a memory function after power is cut off. After power is restored, no need to reset.
- High voltage normal operation indicator
- Fan normal operation indicator light
- High voltage abnormal operation indicator
- Fan abnormal operation indicator light
- Air volume and cleaning time settings switch

- Manual clean button
 

To clean the discharge needle manually, you can press this button. When press this button, the fan will reverse run then stop working.
- Fan speed 1-7 levels increase button.
 

Cleaning time setting: 0-999 hours increase button.
- Fan speed 1-7 levels decrease button.
 

Cleaning time setting: 0-999 hours decrease button.

Press "+" and "-" for more than 5s, the whole machine is locked automatically. Press "\*" and "\*" again for more than 5s, the whole machine is unlocked automatically.
- The fan has seven fixed speeds that can be adjusted F-01-F-07
- Clean time setting can be adjusted H000-H999 (hours)
- Lock function of the whole machine
- Unlock function of the whole machine
- Cleaning of the discharge needle is currently underway

### Technical parameters

Category	Parameters	Category	Parameters
Input voltage	AC220V/50Hz AC110V/60Hz	Wind volume	2.44-5.1m³/min (Single-head)
Ion balance	Automatic ion balance system 0±10V	Ozone concentration	≤0.015ppm (distance 50mm)
Mode of voltage application	AC mode/±2200V	Working temperature	0-40°C
Weight	4.3kg	Working humidity	30-70%RH (No condensation or water droplets)
Power consumption	≤32W	Noise	≤70db

# Working cases for some of the static eliminators

Static eliminating in wafer package and test

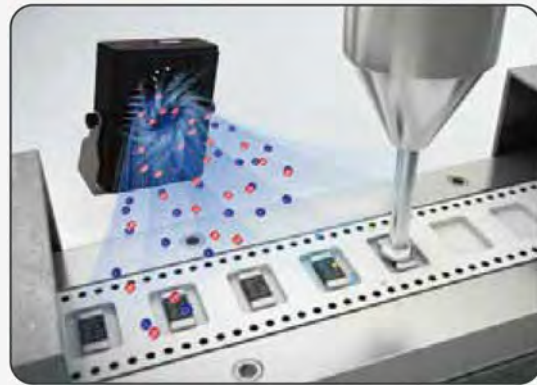

Static eliminating in PCB manufacturing



Static eliminating on wafer surface

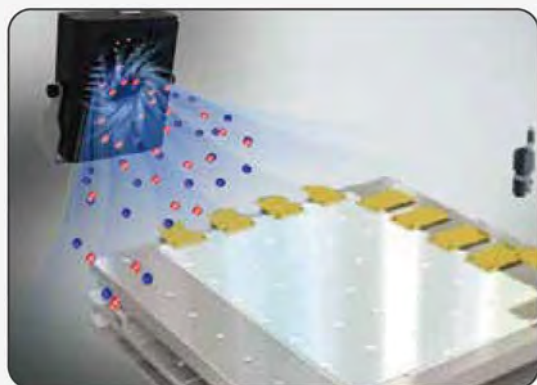

Static eliminating in integrated circuit



Static eliminating in film rolling

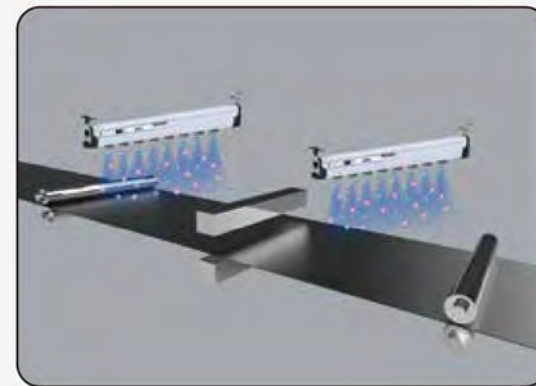

Static eliminating in film forming

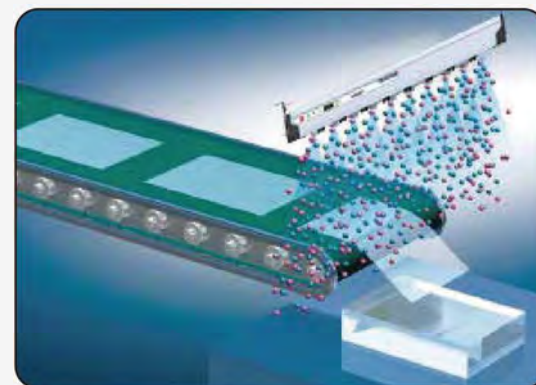

Static eliminating in plastic film packing

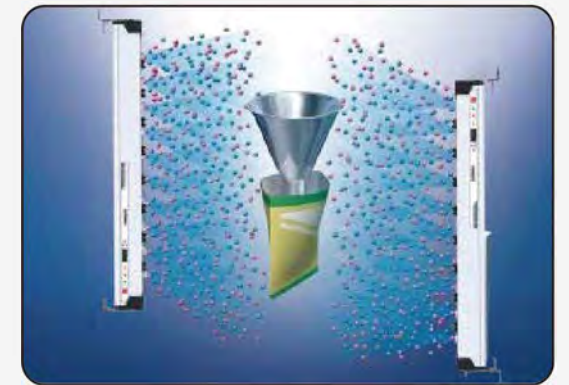

Static eliminating in wafer handling

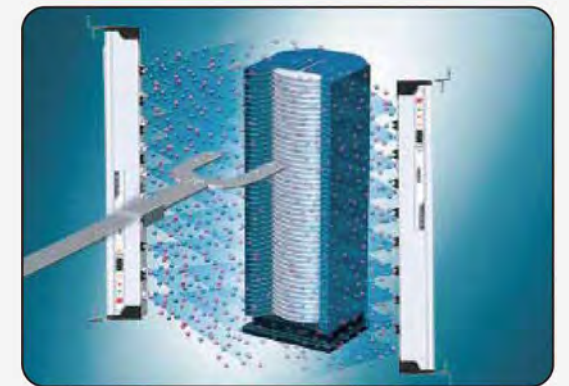

Static eliminating in film process

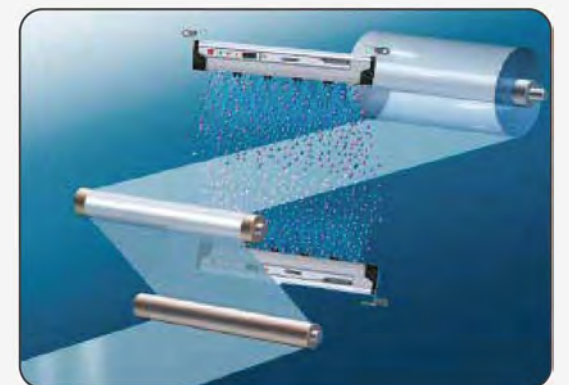

01 CLEANROOM CONSUMABLES  
02 Human protection

03 ELECTROSTATIC CONTROL

### High frequency ion blower nozzle (KZ-10A)

Static Remo	static removal time (positive/negative)	Ion balance (positive/negative)	Test voltage: +1000V- -1000V
Distance			
150mm	0.5s-0.8s	0±10V	1. Be sure to apply compressed air before turning on the power supply. 3. The filter is optional. 4. The above is the test data under specific temperature and humidity conditions.
300mm	0.8s-1.0s		

- Automatic ion balance system, ion balance can reach 0 ± 10V
- Different nozzles can be purchased according to different places of use
- Equipped with special tungsten alloy discharge pin, it is not easy to wear after long term use
- Built in high voltage system, safer and more convenient to use, the inner wall of the shell is sprayed with metallic paint, so that the entire fuselage plays a grounding shielding role
- Equipped with high voltage normal operation indicator light and high voltage abnormal alarm indicator light



**Hot Selling**  
**Anti-static**

- Rapid elimination
- Stable and efficient
- Spray metallic paint on interior wall
- High resistance to electromagnetic interference

### Product Features



- 01 Indicators**  
Power indicator(Green)  
HV/High voltage normal operation(Blue)  
CLEAN/Cleaning reminder indicator(Yellow)  
H.V.ALARM/High voltage abnormal operation(Red)  
Equipped with I/O control,high voltage alarm feedback
- 02 More details**  
Performance parameters and product detail refer to KZ.10C

### Traditional way(commercial frequency)

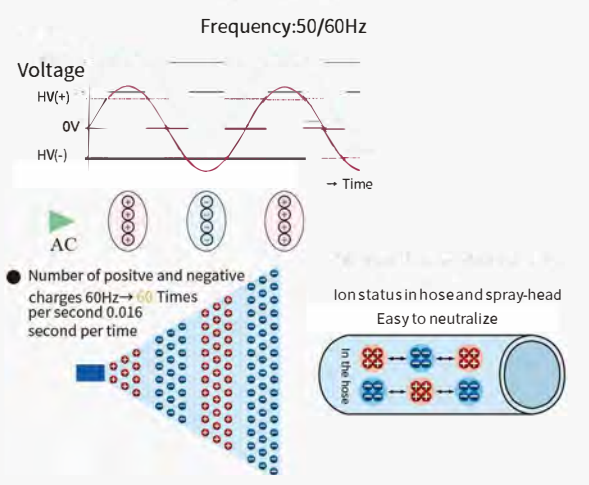

### High-frequency mode

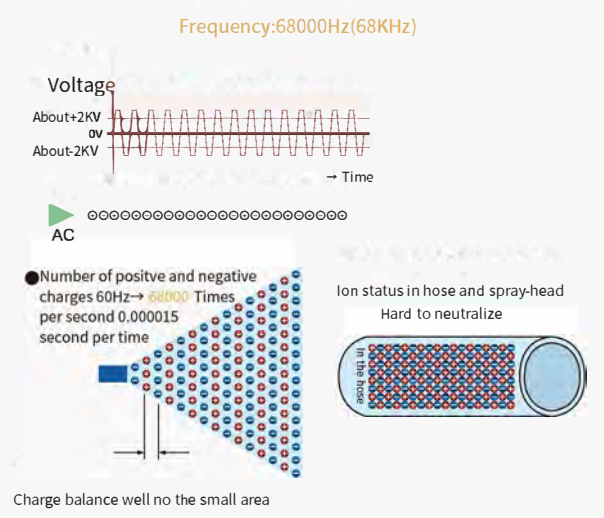

Model	Input voltage	Current	Airflow applied	Temperature and humidity	Power consumption
KZ-10C/KZ-10A/KZ-10A SY HPJ	DC24V	60mA	Clear air(without water and oil)	0-40°C 30-70%RH	≤4.85W
Ion generated way	Ion balance	Ozone concentration(ppm)	Tube diameter	Air pressure application range(MPa)	Gas flow
High frequency AC type	Automatic ion balance system 0±10V	≤ 0.04ppm(50mm,0.2MPa)	φ6	0.1-0.5MPa	≤112.5L/min

### Electrostatic field tester (FMX-004)

- The electrostatic tester is a multi-function digital tester equipped with a single-chip computer. It is a non-contact portable electrostatic field measuring instrument. measure the electrostatic voltage value on the surface of the object and measure the ion balance of the electrostatic elimination equipment
- The housing is made of anti-static material and has a grounding buckle to ensure correct and reliable measurement results. The compact design is palm-sized
- The device uses a large-size LCD display, which can clearly present numbers and graphics, and the display effect is clear at a glance. In dark environment, the panel can light up to ensure that the display content is clearly visible
- Equipped with ion balance measuring plate to measure the residual voltage and ion balance of static elimination equipment
- The measurable range of electrostatic field has been upgraded from the original +/- 20000V to +/- 30000V
- The measurable ion balance range has been upgraded from the original +/- 200V to +/- 300V
- LCD/level display detection data, test data retention, digital clear display, high/low range



### Surface resistance tester (SL-030B)

- Measures impedance, temperature and humidity and complies with ESD standards (S4.1, S7.1 and S11.11). Can test the electrical properties of various materials (10-10ohms/range)
  - Available in 10V/100 V measurement scale for standard countertops and floors
  - Equipped with plastic instrument protection box, easy to carry, and LCD digital display for easy reading
  - Automatic power off function can extend battery life and automatically return to zero to ensure accuracy
  - ASTM, EOS and CECC compliant with parallel electrodes, 5-pound probe and built in impedance probe
  - One-year quality warranty, American quality domestic manufacturing, replaceable probes for extended service life
- Application scenarios:**
- Mainly used in film, ultra-clean room, electronic automation, pharmaceuticals, scientific research and coatings, etc.



### ESD equipment resistance tester (SURPA518)

External dimensions	Accuracy	Power consumption	Weight	Accessories
AC6V.0.3A	1.110 W 58 H 28 1.4MΩ±5%	1.8W	g 110克	1 AC transformer, 2 round wires

- This product is made of high-precision electronic components. It has high precision, fast response speed, strong anti-interference ability, small size, light weight, simple use, etc. It can monitor two wrist bands at the same time. There is an automatic alarm function for the grounding system of the human wrist band, which can monitor the working status of the anti-static wrist band at any time
- Noiseless movement, which can provide reliable guarantee for the wrist strap grounding system in anti-static (personal) work areas
- When the human wrist band grounding system is working normally: no sound, green light is on
- When the grounding system of the human wrist band is broken: there is a beep sound and a red light flashes



### ESD equipment resistance tester (SL-031)

Instrument distance of movable bracket	Weight when setting	What setting	Test accuracy
166mm X 96mm X 40mm	750kΩ-100MΩ	750kΩ-100MΩ	750kΩ-10MΩ
> 150mm			+ 10%-20%

- Can quickly test ESD equipment, and three independent devices (left shoe, right shoe, wrist strap) complete ESD detection at onetime
- Three status displays each, LO (lower than the set value), PASS (within the set value range), HI (higher than the set value) have alarm functions
- If other power adapters are used, the underpower indicator light below 9V will light up, which will affect the test accuracy. The power adapter is AC or DC12V, cannot be greater than 15V!
- The extended communication interface is a dedicated port for downloading programs. Users should not use it or insert it with metal objects



04 Environmental purification

Secondary category

ESD digital monitoring system

B Ion blower

C Static eliminator use case

D Ion nozzle

E Tester

F Anti-static products

G Antistatic table mats, floor mats

H Anti-static door curtains

I Anti-static turnover box

J Antistatic tweezers

K Anti static chair

01 CLEANROOM CONSUMABLES  
02 Human protection

03 ELECTROSTATIC CONTROL

04 Environmental purification

Secondary category

ESD digital monitoring system

B Ion blower

C Static eliminator use case

D Ion nozzle

E Tester

F Anti-static products

G Antistatic table mats, floor mats

H Anti-static door curtains

I Anti-static turnover box

J Anti-static tweezers

K Anti-static chair

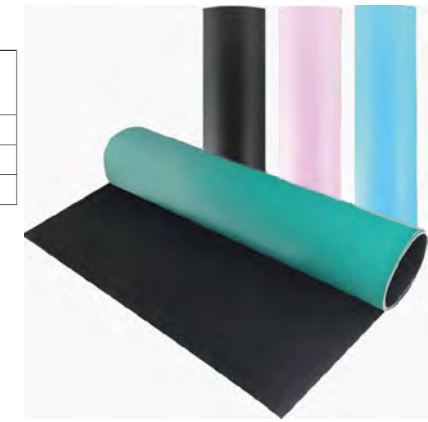

- Environmentally friendly flame retardant
- High temperature resistant
- Anti aging
- Abrasion resistant



### Anti-static mat

Model	Specification
MATM-001	1.2 m10m2mm, bright light
MATM-002	1.2 m10m2mm, matt
MATM-003	1.0 m10m2mm, matt
MATM-004	1.0 m10m2mm, bright light

- Anti-static radio pads are mainly made of anti-(conductive) electrostatic materials and synthetic rubber, which are electrostatic dissipating materials
- The table mat is long-lasting and has good acid, alkali and chemical flux resistance properties

#### Application scenarios:

- Mainly used for laying desktops, assembly lineworksurfaces, shelves and making floor mats, etc., and is suitable for different conditions and environments

Resistance test report    Anti-static report



Hot Selling  
New

- Wear-resistant and non-slip
- Strong flexibility
- Relieve fatigue
- Highly elastic sponge

### Anti-static anti-fatigue floor mat

Model	Specification
MATM-005	90 * 60 * 2cm, thickness ± 0. 2cm

- Quickly removestatic electricity to avoid damage to electronic equipment caused by static accumulation
- Special material and structure reduce foot pressure and make it less tired after standingfor a long time
- Non-slip texture on the surface, wear resistant design on the bottom, safe to use and long life
- The material is smooth, and stains can be wiped away instantly, making it easy for daily care

#### Application scenarios:

- Workshop operation line and long standing work area

Resistance test report    Anti-static report



New

- Environmentally friendly PVC
- Anti-slip and waterproof
- Flame retardant and fire resistant

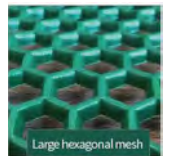

### Anti-slip floor mat

Model	Specification
MATM-007	1.2 m * 15 m * 4.5 mm/roll

- Quickly dissipate static electricity and protect the safety of electronic components
- Good drainage and ventilation to keep the floor dry and reduce odor
- The surface texture is raised, making it difficult to slip when walking, ensuring safety
- The material is tough, anti-wear, and dust and debris are easy to remove

#### Application scenarios:

- All public places can be used



New

- Anti-slip and
- Wear resistant and durable
- Frost-resistant and flame



### Anti-slip floor mat

Model	Specification
MATM-006	anti-slip pattern, GD808, 1.2m * 10m * 2mm/roll

- Built-in electrostatic conductive structure to quickly eliminate static electricity and ensure the stable operation of electronic equipment
- Excellent material: selected PVC material, both flexible and wear resistant, high durability
- Easy laying: lightweight and portable, easy to splice, can be laid quickly by a single person with bare hands
- Easy to clean: smooth surface, daily stains can be wiped away with a damp cloth, easy to take care of

#### Application scenarios:

- Widely used in electronics manufacturing, pharmaceutical chemicals, aerospace, production packaging, medical care, purification engineering floors and commercial centers, etc.

### DC head double circuit anti-static wrist strap

Model	Specification
DC-01	white yarn, wire length 2.0 m-5.0 m

- This product is made of anti-static yarn, which has double circuit and double channel safety function, can quickly guide away static electricity generated by human body/easy to use
- Comfortable to wear, not easy to fall off, with high-elastic PU coil wire made of quick power dissipation (S < 0.1 second)
- Inner core copper wire, better conductive effect than aluminum wire, built in 1MΩ power limiting resistor, strong stretchability, not easy to oxidize and break, durable and safe

#### Application scenarios:

- Electronics manufacturing, communication equipment, medical equipment

Anti-Static Report



Hot Selling  
New

- Fast power dissipation
- Strong resistance
- Good flexibility
- Adjustable tightness

### DPVC anti-static grounding wire

Model	Specification
QS-CHL2518M	spring wire grip + clip, wire diameter 2.2 m (customizable)

- This product is made of PVC wire rolls and can quickly guide the static electricity generated by the worksurface or human body, making it easy to use
- It has fast power dissipation (s < 0.1 seconds) built-in 1MΩ power limiting resistor, strong stretchability, not easy to oxidize and break, durable and safe
- The wire is made of high-elastic PVC coil wirewith inner core copper foil wire, which has better conductive effect than aluminum wire

#### Application scenarios:

- Electronics manufacturing, communication equipment, medical equipment

Anti-Static Report



New

- 0 electrostatic
- Fast release
- Good flexibility
- Wear resistant and durable

### Anti-static grounding base

Model	Panel	cable length	dimensions
MSD-Z12	1.5 MM thick iron plate	1.8 m	38X38X63

- Ground wire is designed to connect ground terminals to countertops, anti-static wrist bands or other precision instruments in static sensitive environments, and can effectively guide static discharge such as countertops or wrist bands
- Simple installation, easy to use, environmentally friendly PU material grounding wire, beautiful appearance, length supports customization

#### Application scenarios:

- Mainly used in semiconductor, chip, microprocessor and other production lines, circuit board production lines, precision instrument production lines, optical product production lines, PCB product production line, plastic factory production line, dust-free workshop, purification workshop, etc.



- Easy to install
- No fear of leakage
- Metal paint stamping

### Anti-static mesh door curtain

Model	Specification
MADC-001	0.3/0.45/2.0 mm * 1.37 m * 30m/roll

- Anti-static door curtains have multiple functions such as soft, transparent, dustproof, anti-static, and free passage of personnel
- Printing black conductive ink on PVC film with good anti-static effect, so that the product grid has good conductivity

#### Application scenarios:

- As a special partition material for anti-static workshops, anti-static door curtains are mainly used in purification workshops and dust-free workshops in the electronics industry, and Electronics manufacturing, watches, food, pharmaceuticals, refrigeration and other industrial fields

Resistance test report    Anti-static report



New

Anti-static

- Isolate heat and cold
- Prevention of static electricity
- Dustproof and soft



### Fully transparent anti-static door curtain

Model	Specification
MADC-008	1T * 800MM * 1500MM

- The material is pure and transparent, and the field of view is almost unobstructed, and it is convenient to observe the situation inside and outside the door at any time
- Can effectively release static electricity and avoid damage to electronic equipment, precision instruments, etc. caused by static electricity accumulation
- Soft and tough texture, not easy to break, long service life, not easy to deform after frequent opening and closing
- Simple structure, complete accessories, no complicated tools required, easy installation

#### Application scenarios:

For internal use in the purification workshop of the electronic factory, to cut off the use of electronic products

Resistance test report    Anti-static report



Hot Selling

New

Anti-static

- No yellowing/high transparency
- Environmentally friendly flame retardant/dustproof

### Anti-static foldable turnover box

Model	Material	Specification	Single box load (KG)
MATB-008	Impact modified PP	400*300*175	30
MATB-009	Impact modified PP	400*300*230	30
MATB-010	Impact modified PP	400*300*280	30

- Made of professional anti-static material, it can effectively conduct static electricity and avoid damage to electronic components in the box caused by static accumulation
- Unique foldable design, which can greatly reduce the occupied space when not in use, facilitate storage and storage, and improve space utilization
- Has a strong and durable structure, can withstand friction and collision during daily handling and stacking, and is not easily damaged
- The design fully considers the convenience of handling, equipped with reasonable handles or rollers, etc., which can be easily transported and transferred, significantly improving logistics turnover efficiency

RoHS report    Anti-static report



New

Anti-static

RoHS

- Environmentally friendly material
- Sturdy and thick
- Wear-resistant and drop-resistant

### Anti-static folding card box

Model	Specification	Folded Height	Unfolded Height
MADC-001	1200*1000*975	406	500

- High quality anti-static material, quickly expels static electricity, avoids damage to electronic components and dust adsorption, used in electrostatically sensitive industries such as electronic manufacturing
- Clever and foldable design, it can be quickly folded when not in use, greatly reducing the floorspace and effectively utilizing storage and transportation space
- Solid structure, made of high-strength materials, resistant to collision and friction during handling, not easy to deform when stacked, stable and reliable, reducing replacement costs
- Easy handling, equipped with reasonable handles or flexible rollers, easy operation in all aspects of logistics, improving cargo turnover speed

RoHS report    Anti-static report



New

Anti-static

RoHS

- Environmentally friendly material
- Sturdy and thick
- Wear-resistant and drop-resistant

### Anti-static mesh door curtain

Mod	Specification
MATB-001	21 # Turnover Box
MATB-002	5 # Turnover Box
MATB-003	3 # Turnover Box
MATB-004	11 # Turnover Box

- Non-toxic, odorless, moisture-resistant, corrosion-resistant, lightweight, durable, stackable
- The anti-static injection molding turnover box is based on polypropylene (PP). By adding carbon powder, the carbon powder plays a role in conducting current and gives the turnover box strong mechanical properties
- Anti-static/conductive effects can be achieved when the surface and volume resistivity is below 10 to the ninth power of ohms/cm2

RoHS report    Anti-static report



Anti-static

RoHS

- Shock resistant and wear-resistant
- Anti-aging
- Easy to clean

### Anti-static floor cover enclosure box

Model	Specifications (outer diameter)	Single box load (KG)
MATB-012	1200*1000	500
MATB-012	1200*800	500
MATB-012	1140*980	500
MATB-012	1140*1140	500

- Effectively eliminate static electricity and protect items from static electricity interference
- Easy to open and close, easy to access items, good sealing
- Can withstand certain pressure to protect the safety of items during transportation
- Quick assembly and disassembly without complicated tools, saving time

RoHS report    Anti-static report



New

Anti-static

RoHS

- Good sealing
- Rugged and durable
- Strong load-bearing capacity

### Anti-static EU turnover box

Model	Material	Specification	Single box load (KG)
MATB-016	Impact modified PP	600*400*340	30
MATB-017	Impact modified PP	600*400*175	20
MATB-018	Impact modified PP	1200*400*230	20

- Follow unified specifications, strong compatibility, conducive to logistics and warehousing operations, excellent materials, impact resistance, wear resistance, corner reinforcement
- The bottom and top of the box can be nested, with handling parts to improve efficiency, the surface is smooth, easy to clean, and meets hygienic requirements
- Transparent or windowed to facilitate viewing the contents of the box, and labels can be pasted to achieve full traceability of the goods. Long service life, reduces costs and waste, can be recycled after waste, environmentally friendly and economical

RoHS report    Anti-static report



Hot Selling

conforms to EP

New

Anti-static

RoHS

- Good sealing
- Rugged and durable
- Strong load-bearing capacity

### Anti-static HP turnover box

Model	Material	Specification	Single box load (KG)
MATB-019	Impact modified PP	650*435*330	30
MATB-020	Impact modified PP	650*435*260	20
MATB-021	Impact modified PP	650*435*210	20

- Made of tough and durable materials, resistant to impact and wear, ensuring long-term use
- The interior layout is scientific, adapting to a variety of items, and effectively utilizing space
- Equipped with handles and fork slots to facilitate forklifts and manual handling, improving logistics efficiency
- Unique design such as HP logo on the appearance, which facilitates quick sorting and reduces errors

RoHS report    Anti-static report



conforms to EP

New

Anti-static

RoHS

- Good sealing
- Rugged and durable
- Strong load-bearing capacity

Anti-static tweezers

- Mixed injection molding with new polypropylene raw materials and conductive materials, good anti-static performance and controllability
- Different use environment requirements such as pointed head, round head, elbow, etc.
- Optional degaussing 302 stainless steel tweezers, hardness HRC40-45°

Application scenarios:

- Clamping and installation of electronic components, welding and maintenance of circuit boards, assembly and adjustment of movement parts
- Sample processing in chemical laboratories, cell manipulation in biological experiments



Anti-static  
RoHS

High temperature durability    good closure    not easy to deform

RoHS report    Anti-static report

Model	Material	Magnetic	Hardness	Overall Length	Kneading Force	New
MSA-19 Gold Feather Clip	Special Stainless Steel	none	HRC40~50°	130mm	120±10克	

**Product Features:**

- Durable, stable quality and affordable price
- Can replace foreign similar tweezers
- High hardness stainless steel material

Model	Material	Magnetic	Hardness	Overall Length	Kneading Force	New
MSA-18 Dolphin Clip	Special Stainless Steel	none	HRC40~50°	125mm	120±10克	

**Product Features:**

- Corrosion, acid and alkali resistance
- Can replace foreign similar tweezers
- High hardness stainless steel material

Model	Material	Magnetic	Hardness	Overall Length	Kneading Force	New
SS-JP	Special Stainless Steel	none	HRC40~50°	140mm	250±10克	

**Product Features:**

- Fine tip, capable of holding 0.01 mm object
- Non-magnetic, acid and alkali resistant, anti-corrosion
- Laser precision welding body
- Rugged and durable, not easy to disconnect

Model	Material	Magnetic	Hardness	Overall Length	Kneading Force	New
5SA-JP	Special Stainless Steel	none	HRC≥45°	110mm	250±10克	

**Product Features:**

- Fine tip, capable of holding 0.01 mm object
- Non-magnetic, acid and alkali resistant, anti-corrosion
- Laser precision welding body
- Rugged and durable, not easy to disconnect

Model	Material	Magnetic	Hardness	Overall Length	Kneading Force	New
00-JP	Special Stainless Steel	none	HRC≥45°	135mm	250±10克	

**Product Features:**

- Fine tip, capable of holding 0.01 mm object
- Non-magnetic, acid and alkali resistant, anti-corrosion
- Laser precision welding body
- Rugged and durable, not easy to disconnect

Model	Material	Magnetic	Hardness	Overall Length	Kneading Force	New
6A-SA	Special Stainless Steel	none	HRC40~45°	113mm	250±10克	

**Product Features:**

- The head is bent at 80°, and the clamping force is high
- Swiss Precision Process
- Laser welding rugged
- Hand grinding tweezers

Model	Material	Magnetic	Hardness	Overall Length	Kneading Force	New
7SA-JP	Special Stainless Steel	none	HRC≥45°	116mm	250±10克	

**Product Features:**

- Fine tip, capable of holding 0.01 mm object
- Non-magnetic, acid and alkali resistant, anti-corrosion
- Laser precision welding body
- Rugged and durable, not easy to disconnect

Model	Material	Magnetic	Hardness	Head shape	Overall Length	Kneading Force	New
34A-SA	Special Stainless Steel	none	HRC40~45°	Long flat head	120mm	250±10克	

**Product Features:**

- Swiss Precision Process
- Laser welding rugged
- Hand grinding tweezers

Model	Material	Magnetic	Hardness	Head shape	Overall Length	Kneading Force	New
35A-SA	Special Stainless Steel	none	HRC40~45°	short flat head type	120mm	250±10克	

**Product Features:**

- Swiss Precision Process
- Laser welding rugged
- Hand grinding tweezers

Model	Material	Magnetic	Hardness	Head shape	Overall Length	Kneading Force	New
36A-SA	Special Stainless Steel	none	HRC40~45°	bay shank flat head type	120mm	250±10克	

**Product Features:**

- Swiss Precision Process
- Laser welding rugged
- Hand grinding tweezers

Model	Material	Magnetic	Hardness	Overall Length	Kneading Force	New
101-SA	Special Stainless Steel	none	HRC40~50°	110mm	120±10克	

**Product Features:**

- Tweezers with circular opening, specially used for clamping cylindrical objects
- Swiss Precision Process
- Laser welding rugged
- Hand grinding tweezers

Model	Material	Magnetic	Hardness	Overall Length	Kneading Force	New
102-SA	Special Stainless Steel	none	HRC40~50°	120mm	120±10克	

**Product Features:**

- Good tip hardness, special for clamping cylindrical objects
- Swiss Precision Process
- Laser welding rugged
- Hand grinding tweezers

Model	Material	Magnetic	Hardness	Overall Length	Kneading Force	New
103-SA	Special Stainless Steel	none	HRC40	120mm	120±10克	

**Product Features:**

- High precision, high hardness
- Non-magnetic, acid and alkali resistant, anti-corrosion
- Strong stretching without deformation
- Rugged and durable, not easy to disconnect

Model	Material	Magnetic	Hardness	Overall Length	Kneading Force	New
AC-SA	Special Stainless Steel	none	HRC40~45	110mm	120±10克	

**Product Features:**

- Thickened tweezers body, high clamping force
- Swiss Precision Process
- Laser welding rugged
- Hand grinding tweezers

Model	Material	Magnetic	Hardness	Overall Length	New
91-4L	Special Stainless Steel	none	HRC ≥ 35°	125mm	

**Product Features:**

- Unique design, easy to clamping the chip
- Non-magnetic, high hardness, wear resistance, acid resistance
- Good symmetry and balance, polished tail without scratches
- Suitable for clamping a variety of precision parts

Model	Material	Magnetic	Hardness	Overall Length	New
91-5L	Special Stainless Steel	none	HRC ≥ 35°	140mm	

**Product Features:**

- Unique design, easy to clamping the chip
- Non-magnetic, high hardness, wear resistance, acid resistance
- Good symmetry and balance, polished tail without scratches
- Suitable for clamping a variety of precision parts

Model	Material	Magnetic	Hardness	Overall Length	New
91-6L	Special Stainless Steel	none	HRC ≥ 35°	130mm	

**Product Features:**

- Unique design, easy to clamping the chip
- Non-magnetic, high hardness, wear resistance, acid resistance
- Good symmetry and balance, polished tail without scratches
- Suitable for clamping a variety of precision parts

Model	Material	Magnetic	Hardness	Overall Length	New
91-3T	Special Stainless Steel	none	HRC ≥ 35°	140mm	

**Product Features:**

- Unique design, easy to clamping the chip
- Non-magnetic, high hardness, wear resistance, acid resistance
- Good symmetry and balance, polished tail without scratches
- Suitable for clamping a variety of precision parts

Model	Material	Magnetic	Hardness	Overall Length	New
91-4T	Special Stainless Steel	none	HRC ≥ 35°	125mm	

**Product Features:**

- Unique design, easy to clamping the chip
- Non-magnetic, high hardness, wear resistance, acid resistance
- Good symmetry and balance, polished tail without scratches
- Suitable for clamping a variety of precision parts

Model	Material	Magnetic	Hardness	Overall Length	New
91-5T	Special Stainless Steel	none	HRC ≥ 35°	140mm	

**Product Features:**

- Unique design, easy to clamping the chip
- Non-magnetic, high hardness, wear resistance, acid resistance
- Good symmetry and balance, polished tail without scratches
- Suitable for clamping a variety of precision parts

Model	Material	Magnetic	Hardness	Overall Length	New
91-6T	Special Stainless Steel	none	HRC ≥ 35°	130mm	

**Product Features:**

- Unique design, easy to clamping the chip
- Non-magnetic, high hardness, wear resistance, acid resistance
- Good symmetry and balance, polished tail without scratches
- Suitable for clamping a variety of precision parts

Model	Material	Magnetic	Surface resistance	Hardness	Overall Length	Head material	New
ESD259	AISI302	none	102~1012Ω	HRC ≥ 35°	130mm	PPS 1x10Ω	

**Product Features:**

- Good elasticity
- Use lightweight and release static electricity

### PU Anti-static Back Chair

Model	Specification
MSD-284	seat: 415MM410MM30MM, back: 370MM260MM30MM
MSD-288	seat: 470MM440MM35MM, back: 450MM315MM33MM

The chair surface has high strength and hardness, wear-resistant and corrosion-resistant, impact-resistant, fission-resistant, heat dissipation and breathability, and comfortable texture. Surface resistance:  $10^9 \sim 10^{10} \Omega$ . The height range of the lifting gas rod is 580MM-800MM, the independent footrest can be adjusted up and down, the aluminum alloy five-star foot, the chair foot radius is 320MM, and can be equipped with anti-static foot pads or anti-static wheels.

**Application scenarios:**  
Used in electronic production workshops, laboratories, dust-free workshops

[Resistance test report](#) [Anti-static report](#)



**Hot Selling**  
**Anti-static**

- Breathable and comfortable
- Wear resistance and corrosion
- Fission resistance
- 360° rotation

### PU anti-static four-hole round chair

Model	Specification
MSD-289	seat cushion size: $\Phi 335$ * thickness 30mm

Chair surface characteristics: high strength, high hardness, wear resistance, corrosion resistance, impact resistance, fission resistance, heat dissipation and breathability, comfortable texture.  
Surface resistance:  $10^9 \sim 10^{10} \Omega$ .  
Lifting height range: 420MM-560MM, chair foot radius: 220MM, chair foot material: steel electroplated five-star feet with ring.  
Accessories: metal conductive chain, can be equipped with anti-static floor mats or anti-static wheels.

**Application scenarios:**  
Used in electronic production workshops, laboratories, dust-free workshops

[Resistance test report](#) [Anti-static report](#)



**Anti-static**

- Breathable and comfortable
- Wear resistance and corrosion
- Fission resistance
- 360° rotation

### Anti-static leather back chair

Model	Specification
MSD-285	Seat surface size: 430MM * 400MM, back size: 400MM * 300MM

The chair surface has high strength and hardness, wear-resistant and corrosion-resistant, impact-resistant, fission-resistant, heat dissipation and breathability, and comfortable texture. Blue and black can be customized.  
Surface resistance:  $10^9 \sim 10^{10} \Omega$ .  
Adjustable height range of lifting air rod: 420MM-560MM, steel electroplated five-star feet.  
Foot radius: 260MM, can be equipped with nylon plastic wheels or fixed foot cups.

**Application scenarios:**  
Used in electronic production workshops, laboratories, dust-free workshops

[Resistance test report](#) [Anti-static report](#)



**Anti-static**

- Breathable and comfortable
- Wear resistance and corrosion
- Fission resistance
- 360° rotation

### Anti-static leather round chair

Model	Specification
MSD-287	Seat Diameter: 320MM

The chair surface has high strength and hardness, wear-resistant and corrosion-resistant, impact-resistant, fission-resistant, heat dissipation and breathability, and comfortable texture. Blue and black can be customized.  
Surface resistance:  $10^9 \sim 10^{10} \Omega$ .  
Adjustable height range of lifting air rod: 420MM-560MM.  
Available with anti-static floor mats or anti-static wheels.

**Application scenarios:**  
Used in electronic production workshops, laboratories, dust-free workshops

[Resistance test report](#) [Anti-static report](#)



**Anti-static**

- Breathable and comfortable
- Wear resistance and corrosion
- Fission resistance
- 360° rotation

# ENVIRONMENTAL PURIFICATION

Ultra-clean technology engineering

- Purification and filtration series
- Clean working environment series
- Clean cabinet series
- Clean room cart series
- Plastic/Packaging Series



To prevent micro-contamination and empower high technology.

## Washable plate filter

Nominal size (inch)	actual size (mm)	rated resistance (Pa)	rated face velocity (m/s)
12*12*1	289*289*21	55	2.5
12*20*1	289*492*21	55	2.5

- The primary plate filter is widely used in the primary filtration section of ventilation systems in industrial, commercial and civil buildings because of its reusability, easy installation, low resistance, and high dust holding capacity
- Aluminum frame, strong and lightweight, easy to install and remove
- High quality filter material, reasonable design, high dust holding capacity, low resistance
- Clean and reuse, saving costs
- Wide range of wind speed applications, suitable for various occasions
- Efficiency level: G3, G4, M5 (EN779)



- Intense cleansing
- Made to last
- Electrostatic filter cotton
- Washable filter element



## High dust capacity primary effect bag filter

Actual size (mm)	Number of bags (PCS)	Filter area (m²)	Air volume (m³/h)	Initial resistance (G3)
594*594*305	8	3.2	3400	65
289*594*305	4	1.6	1700	65
594*594*610	8	6.4	3400	45
289*594*610	4	3.2	1700	45

- High dust holding capacity, long service life
- G3, G4 efficiency tested according to EN779
- Maximum operating temperature 90 °C
- Frame material thickness is optional, quality assurance
- Stable structure and reliable performance



Hot Selling

- High efficiency filtration
- Long life
- Environmentally friendly and non-toxic

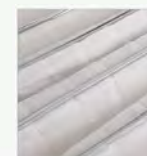

## Box type medium efficiency filter with partition plate

Model	size	wind speed	initial resistance (M6)
Single flange/double flange	610*610*292	2.5	120
Single flange/double flange	305*610*292	2.5	120
Single flange/double flange	610*610*150	1.3	40
Single flange/double flange	305*610*150	1.3	40

- Preferred materials, strong construction, easy to transport and install
- High quality double-layer glass fiber filter paper, microfiber, moisture-proof, fire-resistant
- Efficiency level: M6-F8 (EN779)
- UL900 certified, box-type partition filter, high air volume expanded filter surface, compact and lightweight structure
- Widely used in medium-efficiency filtration sections of various industrial, commercial and civil building ventilation systems



UL900 certified

- Microfiber
- High dust holding capacity
- Low resistance
- Moisture-proof and fire-resistant



## Pleated plate primary filter

Nominal size (inch)	actual size (mm)	Rated resistance	Rated resistance
12*12*1	289*289*22	50	113
12*20*1	289*492*22	50	113

- The primary plate filter has the characteristics of low resistance, high dust holding capacity, easy installation and disassembly, and has passed UL900 certification
- High quality filter material, reasonable design, strong double-layer moisture-proof paper frame structure
- Wide range of wind speed applications, suitable for various occasions

### Application scenarios:

- Mainly used in the primary filtration section of various industrial, commercial and civil building ventilation systems



UL900 certified

- Electrostatic cotton
- Rugged and durable
- High dust holding capacity
- Eco-friendly and non-toxic



- 01 Cleanroom cleaning
- 02 Human protection
- 03 Electrostatic control
- 04 ENVIRONMENTAL PURIFICATION**
- Secondary category
- A Filters
- B Filter cotton-FFU
- C Air shower room-Transfer window
- D workbench
- E Dust-free cabinet series
- F Clean Room Trolley
- G Packaging pouch

- 01 Cleanroom cleaning
- 02 Human protection
- 03 Electrostatic control

# 04 ENVIRONMENTAL PURIFICATION

- Secondary category
- A Filters
- B Filter cotton-FFU
- C Airshower room-Transfer window
- D workbench
- E Dust-free cabinet series
- F Clean Room Trolley
- G Packaging pouch

## High efficiency filter cotton

Specification	Model	Remark
1M*20M*5MM	FRS-01	Other sizes can be customized if required
1M*20M*10MM	FRS-02	Other sizes can be customized if required
1M*20M*20MM	FRS-03	Other sizes can be customized if required
1M*20M*30MM	FRS-04	Other sizes can be customized if required

- High-efficiency air filter cotton is specially designed for filtration at the end of the spray booth, which can filter out all particles that can damage the quality of the spray paint
- Can filter out all particles larger than 0.5 μm, and has self-extinguishing properties when exposed to fire
- Complies with European and American fire classification standards (e.g. DIN53438-F1 and UL900-class1)

**Application scenarios:**  
 • Mainly used for primary plate and bag filters



- Self-extinguishing in case of fire
- Good water permeability
- Thickened encryption
- Intense filtration

## AC FFU

Specification	Material	Wind speed
1175*575*300	Aluminized Sheet, Stainless Steel	0.45m/s±20%

- FFU fan filter unit can be modularly connected
- Equipped with primary and high-efficiency filters, top air suction, evenly sending filtered air at a wind speed of 0.45 m/s ± 20%
- Using German EBM direct-drive high-efficiency centrifugal fan, with a service life of over 50,000 hours, low noise, maintenance-free, low vibration, stepless speed regulation, energy saving, stable operation, digital speed regulation and support computer centralized control
- Suitable for assembled ultra-clean production lines, single or multiple units can be connected in series
- The shell is made of stainless steel, aluminum alloy and cold-rolled steel plate, which is lightweight, corrosion-resistant and beautiful

**Application scenarios:**  
 • Mainly used in clean rooms, clean workbenches, clean production lines, assembled clean rooms and local 100-level applications



- Strong air volume
- Ultra-low noise
- Green energy saving
- Made to last

## DC FFU

Specification	Material	Wind Speed	Noise	Power	Vibration Value
1175*575*300	Alu-zinc sheet	0.45m/s	50db(a)	87W	0.5mm/s

- Select a customized permanent magnet DC brushless motor, calibrate the dynamic balance of the impeller, and improve the fan efficiency by optimizing the shape, size and winding method of the internal winding coil of the motor (such as adjusting the length, width, pitch, etc. of the winding coil)
- The fan efficiency is improved by approximately 33.3% and the energy saving rate is approximately 58.5%
- Study the principles of energy-saving technology to reduce energy consumption, explore new energy-saving fans to improve efficiency, optimize the control system to achieve intelligent management, develop efficient algorithms to accurately control operations, and verify energy-saving effects based on actual cases



- Intense cleansing
- Strong air volume
- Ultra-low noise
- Green energy saving

## Advanced fan filter unit FFU

Specification	Material	Wind Speed
1175*575*300	Galvanized Steel Sheet	0.45m/s±20%

- The full name of FFU is Fan Filter Unit. FFU is the fan filter unit. It is a modular terminal air supply device with its own power and filtration function
- The use of CSC compatible controller can effectively reduce the influence of harmonics on the motor and prolong the service life. Built-in PFC adjustment circuit, the measured initial voltage section power factor is more than 98%
- Equal cross-section lengthened multi-air duct design eliminates vortices, backflow and other phenomena, and improves the uniformity of air outlet. CFD airflow simulation reduces pressure loss and energy loss, and improves the efficiency of the whole machine. Optimize the inclination angle of the fan blade, enhance the aerodynamics of the impeller, and reduce the internal flow loss of the impeller. Horn tuycand curved chassis design improve airflow organization, reduce inlet and outlet turbulence, and improve impeller efficiency
- FFU has two-stage filters: primary and high-efficiency filters. The fan draws the air from the top of the FFU and filters it through a high efficiency filter



- Rapid cleaning
- Strong air volume
- Ultra-low noise
- Green energy saving

## Advanced fan filter unit FFU

Specification	Nozzle speed	Air volume	Filtration efficiency
1400*1400*2100	≥20m/sec	2000m³/h	≥0.3μm dust≥99.95%(sodium flame method)

- The air shower is a highly versatile local purification equipment. It is installed at the partition wall between clean rooms and non-clean rooms. It is used to blow and remove dust when people and objects enter the clean area to reduce the entry of dust sources
- The shell is made of high-quality cold-rolled steel plate or SUS304 stainless steel plate processed by CNC machine tools and multiple treatments, with a smooth and beautiful surface
- The door is SUS304 stainless steel full see-through glass door, high strength and beautiful
- Adopts one-way channel air shower, photoelectric induction automatic blowing after closing the door, electronic interlocking, LCD screen, infrared induction automatic blowing and imported door closer, the interior and bottom plate are all SUS304 stainless steel plates, equipped with stainless steel multi-angle adjustable nozzles and large air volume low noise centrifugal fan

**Application scenarios:**  
 • Mainly used in food and beverage, electronics, medicine and health industries and scientific research fields



- Infrared induction
- Automatic blowing shower
- Copper core motor
- Ultra-fast wind speed

## Ultraviolet sterilization transfer window

Model	Working area	Dimensions	Door control method
FC-CDC-500M	380×430×420	500×500×500	Mechanical interlocking
FC-CDC-600M	480×530×520	600×600×600	Mechanical interlocking
FC-CDC-500E	360×430×420	500×500×500	Mechanical interlocking
FC-CDC-600E	460×530×520	600×600×600	Mechanical interlocking

- The transfer window is an air purification equipment used in conjunction with clean workshops. It is suitable for the transfer of medium and small goods between clean rooms or between clean rooms and non-clean rooms. Through the use of transfer windows, the number of doors opened and closed in the clean room can be reduced, and contamination in the clean area can be minimized
- The box is made of high-quality SUS304 stainless steel or steel plate baking paint, which is smooth and easy to clean. The double doors are interlocked to effectively prevent cross-contamination
- Special sanitary grades silicone sealing strip to ensure air tightness, equipped with UV germicidal lamp, safe structural design, easy installation, good clean room compatibility



- Clear window
- Good sealing
- Ultraviolet sterilization
- Purification and dust removal

## Lifting door clean workbench

Model	Working area	Maximum power consumption	Power supply	Weight	Operator
SW-CJ-1A	820×450×580mm	0.4kW	220V 50Hz	110kg	Single
SW-CJ-2A	1650×450×580mm	0.8kW	220V 50Hz	200kg	Double

- The work surface adopts SUS304 high-quality stainless steel arc humanized design
- It not only effectively improves working comfort, but also has antibacterial, corrosion-resistant and cleaning functions
- Adopt adjustable air volume fan system and touch switch to adjust voltage to ensure that the wind speed in the working area is always in an ideal state
- Horizontal flow pattern, open table top, easy to operate

**Application scenarios:**  
 • This is a horizontal oneway airflow clean workbench designed using international advanced technology and manufactured by precision CNC equipment. It is mainly used in electronic machinery, instrumentation, optics, plant tissue culture, scientific research institutions and laboratories, etc. fields



- Efficient sterilization
- Double layer filtration
- Multi-speed regulation
- Resistant to corrosion and embroidery

## Vertical flow clean bench

Model	Working area	Maximum power consumption	Power supply	Weight	Operator
YG-875A/B	875×700×460mm	0.4kW	220V 50Hz	160kg	Single
YG-1450A/B	1450×700×460mm	0.8kW	220V 50Hz	250kg	Double

- Vertical flow pattern, quasi-closed table top
- Effectively prevent external airflow from penetrating and irritating the human body by operating odors
- Adopt an adjustable air volume fan system to ensure that the wind speed in the working area is always in an ideal state
- Equipped with lighting and germicidal lamps to ensure cleanliness
- The front windshield is designed with 5mm fully tempered glass, which can be moved up and down and positioned at will, making single and double-sided operation more convenient and safer

**Application scenarios:**  
 • Mainly used in medical and health, pharmaceutical, chemical experiments and other fields, and provides a local purification workbench in a sterile, dust-free and clean environment



- Sterile and dust-free
- Ultra-low noise
- Multi-speed regulation
- Double layer filtration

- 01 Cleanroom cleaning
- 02 Human protection
- 03 Electrostatic control

# 04 ENVIRONMENTAL PURIFICATION

- Secondary category
- A Filters
- B Filter cotton-FFU
- C Airshower room-Transfer window
- D workbench
- E Dust-free cabinet series
- F Clean Room Trolley
- G Packaging pouch

- 01 Cleanroom cleaning
- 02 Human protection
- 03 Electrostatic control

04 ENVIRONMENTAL PURIFICATION

- Secondary category
- A Filters
  - B Filtercotton - FFU
  - C Airshower room - Transfer window
  - D workbench
  - E Dust free cabinet series
  - F Clean Room Trolley
  - G Packaging pouch

### Film processing workbench

Specification	Material
1500*900*900mm	SUS304 * 1.5 mm drawing plate

- The plate is made of SUS304 1.5mm wire drawing plate and requires punching. The punching diameter is 12mm and the hole center distance is 26mm (full punching).
- No punching at countertop reinforcement
- The skeleton adopts SUS304 3838 \* 1.2 mm bright square tube, and 100 MM high  $\phi$ 8 stainless steel round guardrails are installed on three sides of the desktop
- Install four stainless steel adjusting feet and four 4-inch single-core flat universal wheels
- Can be customized according to customer needs

#### Application scenarios:

- Can be used in dust free workshops, hospitals, laboratories and other places

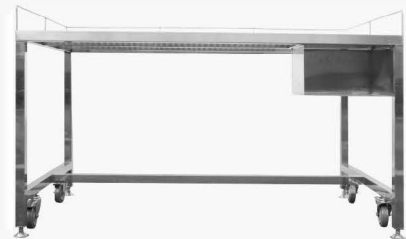

Hot Selling

New

SUS304

- Environmentally friendly and
- Anti-corrosion and wear
- Refuse to rust

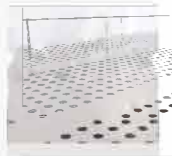

### Stainless steel punching computer desk

Specification	Material
650*325*1470mm	SUS304 * 1.5 mm drawing plate

- The board is made of SUS304 \* 1.5 mm wire drawing board, punched, fully punched, no punching at the reinforcement
- The skeleton is made of square tubes and the guardrail is made of round bars
- Install 4 stainless steel adjusting feet
- Can be customized according to customer needs

#### Application scenarios:

- Can be used in dust free workshops, hospitals, laboratories and other places



New

SUS304

- Anti-corrosion and anti-rust
- Caster mute
- Integral welding
- Strong load-bearing capacity



### Equipment stage

Specification	Material
500*760*955mm	SUS304 * 1.5 mm drawing plate

- The plate is made of 1.5 mm stainless steel brushed plate, full of holes, and no holes are punched at the hidden reinforcement of the countertop
- The skeleton is made of stainless steel 304 38 \* 38 \* 1.2 mm square tube
- Install 4 stainless steel adjusting feet
- Can be customized according to customer needs

#### Application scenarios:

- Can be used in dust-free workshops, hospitals, laboratories and other places



New

SUS304

- Anti-corrosion and anti-rust
- Integral welding
- Strong load-bearing capacity



### Packaging table

Specification	Material
1400*900*1110mm	SUS304 * 1.5 mm drawing plate

- The plate is made of 1.5 mm stainless steel brushed plate; The round tube is made of a bright tube with a diameter of 32mm and a wall thickness of 3.0 mm
- The skeleton is made of a square tube with a side length of 38 mm  $\times$  38 mm and a wall thickness of 1.2 mm; The guardrail adopts a square tube with a side length of 25 mm  $\times$  25 mm and a wall thickness of 1.2 mm
- Four single-core universal brake wheels and four stainless steel adjusting feet are installed at the bottom
- Can be customized according to customer needs

#### Application scenarios:

- Can be used in dust-free workshops, hospitals, laboratories and other places



New

SUS304

- Strong load-bearing capacity
- Reinforced and durable
- Green Environmental Protection
- Anti-corrosion and anti-rust



### Water cup holder

Specification	Material
1500*250*1600mm	SUS304 0.8 mm stainless steel double brushed plate

- The plate is made of SUS304 0.8 mm stainless steel double drawn plate, which is formed by bending and welding
- The pipe is made of SUS304 30 \* 30 \* 1.2 mm stainless steel drawn pipe
- The bottom is equipped with M12 stainless steel adjustment feet, and reinforcing ribs are installed under the tabletop
- Finished products are cleaned according to clean room cleaning standards and coated with cleaning film
- In line with the environmental protection policy, the surface is polished with precision grinding, instead of chemical point electrolytic polishing to avoid environmental pollution

#### Application scenarios:

- Can be used in dust free workshops, hospitals, laboratories and other places



New

SUS304

- Eco-friendly and durable
- Anti-corrosion and wear resistance
- Refuse to rust

### Mobile phone storage cabinet

Specification	Material
1570*300*1660mm	SUS304 0.8 mm stainless steel double brushed plate

- The plate is made of SUS304 0.8 mm stainless steel double drawn plate, which is formed by bending and welding
- The pipe is made of SUS304 30 \* 30 \* 1.2 mm stainless steel drawn pipe
- The bottom is equipped with M12 stainless steel adjustment feet, and reinforcing ribs are installed under the tabletop
- Finished products are cleaned according to clean room cleaning standards and coated with cleaning film
- In line with the environmental protection policy, the surface is polished with precision grinding, instead of chemical point electrolytic polishing to avoid environmental pollution

#### Application scenarios:

- Can be used in dust free workshops, hospitals, laboratories and other places



New

SUS304

- Strong load-bearing
- Thickened material
- Refuse to rust
- Waterproof and moisture resistant



### Glove dispensing cabinet

Specification	Material
1000*400*1300mm	SUS304 * 1.2 mm drawing plate

- The board is made of SUS 304 \* 1.2 mm brushed board with a 5.0 mm plexiglass cover above it
- The guardrail is made of SUS 304 8mm diameter round bar
- The door is double door, equipped with flat handle and strong magnetic suction
- All burrs, acute angles and weld beads are ground and polished to avoid scratching the operator
- Finished products adopt clean room cleaning standards and are coated with cleaning film
- In line with the environmental protection policy, chemical electrolytic polishing (etching) is not used to avoid environmental pollution

#### Application scenarios:

- Can be used in dust-free workshops, hospitals, laboratories and other places



New

SUS304

- Plexiglass cover
- Grinding and polishing
- Refuse to rust
- Waterproof and moisture proof



- 01 Cleanroom cleaning
- 02 Human protection
- 03 Electrostatic control

04 ENVIRONMENTAL PURIFICATION

- Secondary category
- A Filters
  - B Filtercotton - FFU
  - C Airshower room - Transfer window
  - D workbench
  - E Dust free cabinet series
  - F Clean Room Trolley
  - G Packaging pouch

### Special gas cylinder trolley

Specification	Material
1000*500*1100mm	Stainless steel 304 3mm

- The bottom plate is welded with SUS 304 3mm stainless steel plate
- SUS 304 0.25 mm (outer diameter/wall thickness) stainless steel glossy round tube
- The car body is equipped with adjustable elastic stainless steel chain to secure the cylinder more securely
- The bottom is equipped with 2 pieces of 8# nylon directional wheels and 2 pieces of 2# universal nylon wheels, with an overall load capacity of 200KG
- Can be customized according to customer needs

#### Application scenarios:

- Can be used in dust free workshops, hospitals, laboratories and other places



- U-shaped groove
- Anti-corrosion and anti-rust
- Labor-saving and wear-resistant
- Strong load-bearing capacity



Hot Selling

New

SUS304

### Second-story stainless steel trolley

Specification	Material
1100*560*990mm	SUS 304 1.5 mm single mirror panel

- The plate is made of SUS 304 1.5 mm single mirror panel, full hole  $\varnothing 8.2$  P20 bending and welding
- The pipe material is  $38 \times 38 \times 1.2$  mm mirror square tube, and the fence is  $\varnothing 10$  round bar
- The bottom is equipped with 4 4-inch flat universal brake conductive wheels
- Can be customized according to customer needs

#### Application scenarios:

- Can be used in dust free workshops, hospitals, laboratories and other places



- Stable and durable
- Resistant to corrosion and embroidery
- Strong load-bearing capacity



New

SUS304

### Anti-static material turnover trolley

Specification	Material
1100*560*990mm	SPCC/SUS304

- Main wire diameter 5.8 mm, wave wire diameter 4.3 mm, surface wire diameter 2.8 mm
- Material SPCC/SUS304, size can be customized according to customer requirements
- Fully automatic butt welding of mesh, no desoldering or missing soldering, corner grinding, single-layer load bearing 150-200KG

#### Application scenarios:

- Can be used in electronic assembly workshops, dust free workshops, SMT workshops, laboratories and other places



- Structural stability
- Anti-corrosion and anti-rust
- Strong load-bearing capacity



### PE purification bag

Model	Specification	Material
PE-01	Can be customized according to customer requirements, thickness/size/color	PE

- The film adopts extrusion blow molding method and is available in LDPE and HDPE
- LDPE is slightly white transparent, soft, nontoxic and tasteless; HDPE is milky white
- Under the same requirements, the thickness of HDPE film can be reduced to 75%~80% of LDPE, greatly reducing the cost
- Both films have good water resistance, moisture resistance, cold resistance, low air permeability and chemical stability. The film has good thermal adhesion and low temperature heat sealing properties, and does not contain silicone oil or amide

#### Application scenarios:

- Mainly used in the primary filtration section of various industrial, commercial and civil building ventilation systems

RoHS report Ion Test Report Cleanliness Report



RoHS

- Good toughness
- Tear resistant
- Dust proof and moisture proof



### Nylon composite bag

Model	Specification	Material
PN-01	Can be customized according to customer requirements, thickness/size/color	Nylon material

- Nylon bag density:  $1.1 \text{ g/cm}^3$ , nylon content up to 99%, PA film (bag) has extremely excellent tensile and puncture strength
- Good barrier effect on common gases ( $\text{O}_2$ ,  $\text{N}_2$ ,  $\text{CO}_2$ ) and odors
- Good flexibility, impact resistance and wear resistance, high transparency and gloss, acid, alkali, grease and various common organic solvents resistance
- Can be used in a wide temperature range ( $-150^\circ\text{C}$ - $180^\circ\text{C}$ ), with good heat sealing performance

#### Application scenarios:

- Mainly used in the primary filtration section of various industrial, commercial and civil building ventilation systems

RoHS report Ion Test Report Cleanliness Report



- Strong barrier
- No adhesive
- Tear resistance and wear resistance
- Not easy to air leak



### Aluminum plastic bag

Model	Specification	Material
AL-01	Can be customized according to customer requirements	Aluminum foil composite

- The structure is usually divided into an outer layer, a barrier layer and a heat sealing layer. The middle barrier layer effectively prevents gas or liquid from penetrating and blocks light
- The inner layer is in contact with the packaging, does not interact with the packaging, is nontoxic, and is a material that meets international standards
- Good heat sealability and mechanical strength, and certain chemical stability
- Common structures are PET/AL/PE (three layers), PET/AL/PA/PE (four layers)

#### Application scenarios:

- Mainly used in electronic and electrical industries, medicine, automobiles, daily flexible packaging, plastic particles, etc.

RoHS report



Hot Selling RoHS

- High temperature resistance
- High barrier
- Puncture resistance
- Healthy and environmental protection



### Anti-static aluminum foil bag

RoHS Anti-static

# NITRILE GLOVES



## Nitrile Glove

### ► Product Description

- Micro textured exterior surface for secure grip
- Flexible and soft, causing less fatigue
- Ambidextrous
- Standards of Compliance: EN455 part 1,2,3,5 & EN374 part 5.
- ASTM D6319
- Applications: Medical/Exam, Industrial/PPE, Food Processing



### ► Specifications:

Powder Free/PF	Size	Require weight (G)	Length (MM)	Palm Width (MM)	Thickness (SINGLE WALL) (MM)			Before/After Aging	
					Finger tip	Palm	Wrist	Elongation (%)	Tensile Strength (Mpa)
PF	S	S=3.5±0.2	240+/-5	85+/-5	0.080-0.120	0.060-0.080	0.050-0.070	≥450%/ ≥400%	≥14 MPa/ ≥14 MPa
	M	M=4.0±0.2	240+/-5	95+/-5	0.080-0.120	0.060-0.080	0.050-0.070	≥450%/ ≥400%	≥14 MPa/ ≥14 MPa
	L	L=4.5±0.2	240+/-5	105+/-5	0.080-0.120	0.060-0.080	0.050-0.070	≥450%/ ≥400%	≥14 MPa/ ≥14 MPa
	XL	XL=5.0±0.2	240+/-5	115+/-5	0.080-0.120	0.060-0.080	0.050-0.070	≥450%/ ≥400%	≥14 MPa/ ≥14 MPa
QUALITY STANDARDS					EN455-1-2-3 EN374-1-2-3-4-5 EN16523 ASTM D6319				

The specs. for other weights. contact the factory directly please

## Nitrile Gloves

### ►Features

- Ultra-thin nitrile gloves provide more dexterity and tactile sensitivity.
- Excellent physical properties, high tensile strength and ultimate elongation.
- Sulphur free, chemical accelerator-free and odor free.
- Exceptional snug fit to hand skin for easier operation.
- Finger textured for a reliable, consistent grip.
- Comfortable and reliable hand protection.

### ►Applications



- Dentistry / Dental Hygiene
- Healthcare and Nursing
- Medical Purpose /Examination
- Beauty /Cosmetology

### ►Certification



- Food and Beverage Processing
- General Housekeeping



### ►Color

Purple Nitrile/Dark Blue Nitrile/Light Blue Nitrile/Green Nitrile

**LENGTH: 9"**

**THICKNESS: 2.4-3.5mil**



## Diamond Texture Nitrile Gloves

### ►Features

- Special Mega Texture design provides reliable hand protection with a more secure grip.
- The texture channels away liquids for a grip that won't quit.
- The thickness resists tearing, for product protection.
- Are compliant with US Food Contact and EU Food Migration Regulations.

### ►Applications



- Automotive
- Sanitation
- Industrial
- Plumbing
- Food Processing
- Chemical

### ►Certification



- Painting



### ►Color

Black / Orange

**LENGTH: 9"**

**THICKNESS: 5-8mil**



# VINYL GLOVES



## Vinyl Glove

### ► Product Description

- PVC
- Smooth
- Latex free
- AQL 1.5, 4.0
- Ambidextrous
- Available in S-XL
- Powdered & Powder free
- Packing: 100 gloves per dispenser, 1000(10x100) pcs per case



### ► Specifications:

Size	Weight (g)	Length (mm)	Palm Width (mm)	Thickness (mm)		
				Fingertips	Palm	Cuff
S	4.0±0.2	240±5	85±5	0.08±0.02	0.06±0.02	0.05±0.02
M	4.5±0.2	240±5	95±5	0.08±0.02	0.06±0.02	0.05±0.02
L	5.0±0.2	240±5	105±5	0.08±0.02	0.06±0.02	0.05±0.02
XL	5.5±0.2	240±5	115±5	0.08±0.02	0.06±0.02	0.05±0.02
TENSILE STRENGTH				≥ 12Mpa		
ELONGATION				≥ 300%		
TESTING METHODS				GB2828		
QUALITY STANDARDS			EN455-1-2-3 EN374-1-2-3-4-5 EN16523 ASTM D5250			

The specs. for other weights, contact the factory directly please.

# COMPOSITE NITRILE GLOVES

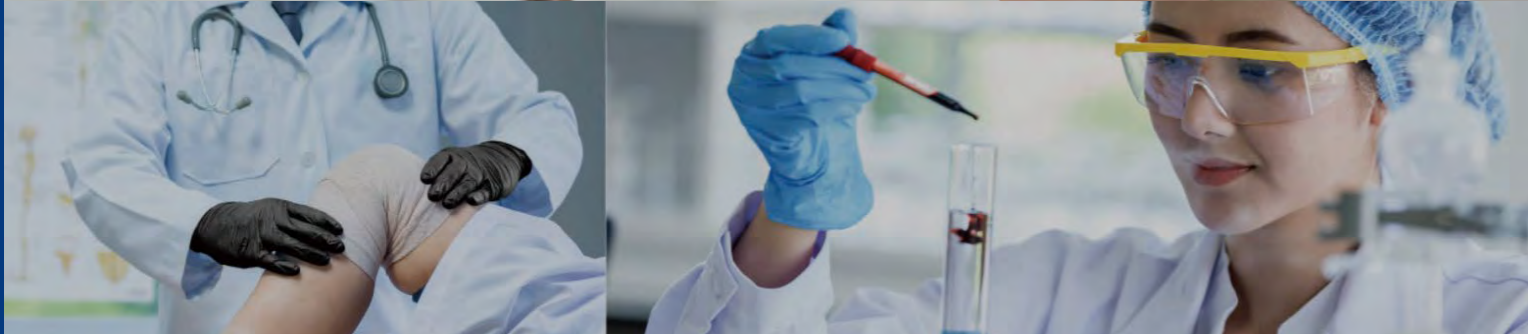

## Disposable Vinyl Gloves

### ► Features

- Made from polyvinyl chloride with a unique formula and production process.
- Ten times more resistant to abrasion than nitrile gloves.
- Strong and durable performance.
- No natural rubber latex protein to reduce risk of allergy.

### ► Applications



- Industrial Purpose / PPE
- Food and Beverage Processing
- General Housekeeping
- Laboratory

### ► Certification

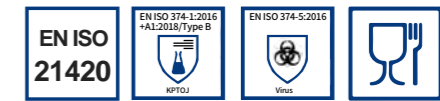

- Beauty / Cosmetology
- Automotive



### ► Color

Blue / Black / Customized

**LENGTH: 9"**

**THICKNESS: 3-3.5mil**



## Disposable Ultra Vinyl Gloves

### ►Features

- Made of high-quality synthetic materials, they are latex-free to reduce the risk of allergic reactions.
- They provide excellent flexibility and tactile sensitivity.
- Compliant with food handling requirements.
- Better performance and premium stretch ability.

### ►Applications



- Medical Purpose/Examination
- Food and Beverage Processing

- Beauty / Cosmetology
- Laboratory

- Healthcare and Nursing
- General Housekeeping

### ►Certification

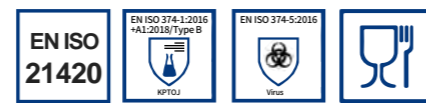

### ►Color

Black / Lilac / Blue

**LENGTH: 9"**

**THICKNESS: 2.7-3.5mil**



## Ultra Vinyl Gloves

### ►Features

- Soft fit for flexibility and comfort in the workplace.
- Unique pearlescent color delivers a silky sheen and provides an elegant user experience.
- Latex-free, which reduces the risk of allergic reactions.

### ►Applications



- Beauty / Cosmetology
- Food and Beverage Processing

- General Housekeeping
- Hotel Cleaning



### ►Color

Shiny Silver / Shiny Pink / Shiny Violet / Shiny Golden

**LENGTH: 9"**

**THICKNESS: 2.7-3.5mil**





# CLEANROOM GLOVES

## Nitrile Gloves (Powder-free)

### ►Features

- Tear resistance, acid and alkali resistance, hypoallergenic, high cleanliness, acid and alkali resistance, grease, fuel oil and various solvents.

- RoHs Report
- Halogen Report
- Silicone oil test report
- Ingredient Report
- Metal test report
- Ion test report

Model	Specification	Package
MNW09-002	9 inch white finger hemp S/M/L/XL	50 pairs/pack 10 packs/box
MNB09-002	9 inch blue finger hemp S/M/L/XL	50 pairs/pack 10 packs/box
MNW12-002	12 inch white finger hemp S/M/L/XL	50 pairs/pack 10 packs/box
MNB12-002	12 inch blue finger hemp S/M/L/XL	50 pairs/pack 10 packs/box



### ►Applications



## Nitrile Gloves (Boxed)

### ►Features

- Good oil resistance, wear resistance, heat resistance, tear resistance, acid and alkali resistance, hypoallergenic, acid and alkali resistance, grease, fuel oil and various solver
- The pockmark surface effect can easily grasp smooth objects and has good puncture resistance, giving it good protection
- No protein, no allergic reaction to human skin, non-toxic, harmless, strong and durable, good adhesion

- RoHs Report
- Halogen Report
- Silicone oil test report
- Ingredient Report
- Metal test report
- Ion test report

Model	Specification	Package
MNB09-003	9 Inch Blue S/M/L/XL	50 pairs/pack 10 packs/box



### ►Applications



## Halogen-free Nitrile Gloves

### ►Features

- Sulfur element & chlorine element content below 900ppm, effectively controlling metal corrosion, point crystallization and other defects, and improving the yield of chip products.
- Newly improved nitrile rubber formula, good elasticity.
- Contains no latex protein, eliminates allergic reactions caused by natural latex.

- RoHs Report
- Anti-Static Report
- Halogen Report
- Cleanliness Report
- Silicone oil test report



Model	Specification	Package
MHF12-001	12 inch white finger hemp S/M/L	50 pairs/pack 10 packs/box



### ►Applications



## Nitrile Gloves For Batteries

### ►Features

- Sulfur element & chlorine element content below 900ppm, can be placed on the cell for more than 72 hours without oxidation reaction.
- Newly improved nitrile rubber formula, good elasticity, wear resistance and puncture resistance.
- Easy to wear; Fits hand shape, sensitive to touch, has the ability to protect against a variety of chemicals, is non-toxic and harmless.

- RoHs Report
- Anti-Static Report
- Halogen Report
- Latex Composition Testing
- Silicone oil test report
- Cleanliness Report



Model	Specification	Package
MHS09 - 001	9 inch white finger hemp S/M/L	50 pairs/pack 10 packs/box

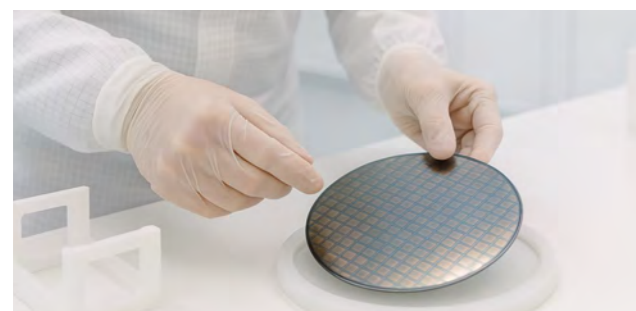

### ►Applications



## Nitrile Gloves (Class 10)

### ►Features

- Cleanliness can reach Class 10, low amount of particulate matter, no fingerprints.
- Good oil resistance, wear resistance, heat resistance, high strength, high elasticity.
- Protein-free, no allergic reaction to human skin.
- Non-toxic, harmless, durable, nitrile gloves can effectively prevent organic solvents.

Model	Specification	Package
MRF12 - 001	12 Inch Translucent S/M/L	50 pairs/pack 10 packs/box



### ►Applications

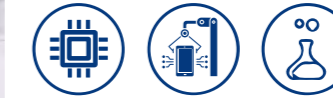

## Nitrile Gloves (Class 100)

### ►Features

- Good oil resistance, wear resistance and heat resistance, high strength, high elasticity, no protein, no allergic reaction to human skin.
- Non-toxic, harmless, strong and durable, nitrile gloves can effectively prevent organic solvents.

- RoHs Report
- Ingredient Report
- Halogen Report
- Metal test report
- Silicone oil test report
- Anti-Static Report
- Ion test report
- Cleanliness Report

Model	Specification	Package
MNW09 - 004	9 inch white finger hemp S/M/L/XL	50 pairs/pack 10 packs/box
MNW12 - 004	9 inch white finger hemp S/M/L/XL	50 pairs/pack 10 packs/box



### ►Applications



## Nitrile Gloves (Class1000)

### ►Features

- Good oil resistance, wear resistance, heat resistance, high strength, high elasticity, effective anti-organic solvents, contains no protein, no allergic reaction to human skin.



Model	Specification	Package
MNW09-005	9 inch white S/M/L/XL	50 pairs/pack 10 packs/box
MNB09-005	9 inch blue S/M/L/XL	50 pairs/pack 10 packs/box
MNW12-005	12 inch white S/M/L/XL	50 pairs/pack 10 packs/box
MNB12-005	12 inch blue S/M/L/XL	50 pairs/pack 10 packs/box



### ►Applications



## Latex Gloves (bagged)

### ►Features

- It is wear-resistant and puncture-resistant, not easy to break, and has good elasticity.
- Unique fingertip texture design to enhance grip and effectively prevent slippage.

- RoHs Report
- Latex Composition Testing
- Silicone oil test report
- Cleanliness Report
- Anti-Static Report



Model	Specification	Package
ML09-001	9 inch S/M/L/XL	50 pairs/pack 10 packs/box
ML09-002	9 inch S/M/L/XL	50 pairs/pack 10 packs/box
ML12-001	12 inch S/M/L/XL	50 pairs/pack 10 packs/box
ML12-002	12 inches 6.0 g/6. 5g/7. 5g/8. 0g	50 pairs/pack 10 packs/box



### ►Applications



## Anti-static PVC Gloves

### ►Features

- Stable anti-static effect  $1 \times 10^6 \Omega \sim 1 \times 10^9 \Omega$ .
- It can prevent static electricity from damaging electronic components, delay their aging, and improve the reliability and life of electronic products.
- High-quality PVC gloves with super toughness and latex-free protein to effectively prevent allergies.
- Fits both hands, enhances the feel, and brings a flexible operation experience.

- RoHs Report
- Anti-Static Report
- Halogen Report
- Cleanliness Report
- Silicone oil test report
- Anti-Static Report

Model	Specification	Package
MAS09-001	9 Inch S/M/L	50 pairs/pack 10 packs/box



### ►Applications



## Disposable PVC Gloves (bagged)

### ►Features

- Universal for left and right hands, curled wrist, easy to wear, strong and durable.
- No skin irritation or allergy, Resistance to weak acids and alkalis, low ion content, flexibility, good touch, lightweight, flexible operation.

- RoHs Report
- Silicone oil test report
- Halogen Report
- Cleanliness Report
- Anti-Static Report
- Ion test report

Model	Specification	Package
MP09-001	9 Inch S/M/L/XL	50 pairs/pack 10 packs/box
MP12-001	12 inch S/M/L/XL	50 pairs/pack 10 packs/box



### ►Applications



# Disposable Protective Clothing



## PP Velcro Workwear

### ► Features

- Made of environmentally friendly and non-toxic PP material, safe and green.
- It has a compact structure and can effectively block dust, debris, etc.
- Moreover, PP molecular structure is special, breathable and not stuffy.

Model	Fabric	Properties	Main material	Uses
PNC-01	PP30g single collar Velcro	dustproof, isolate pollutants	PP	maintain the cleanliness of the environment

### ► Details display



### ► Applications



## PP Velcro Workwear (Knitted Sleeve)

### ► Features

- Made of environmentally friendly and non-toxic PP material, safe and green.
- It has a compact structure and can effectively block dust, debris, etc.
- Moreover, PP molecular structure is special, breathable and not stuffy.

Model	Fabric	Properties	Main material	Uses
PNC-02	PP30g single collar button model	Dustproof, isolate pollutants	PP	Maintain the cleanliness of the environment

### ► Details display



### ► Applications



## PP Button Workwear

### ►Features

- Made of environmentally friendly and non-toxic PP material, safe and green.
- It has a compact structure and can effectively block dust, debris, etc.
- Moreover, PP molecular structure is special, breathable and not stuffy.

Model	Fabric	Properties	Main material	Uses
PNC-03	PP30g single collar button model	Dustproof, isolate pollutants	PP	Maintain the cleanliness of the environment

### ►Details display

**01**  
**Neckline Design**  
Three-dimensional, beautiful and practical



**02**  
**Buttons**  
Easy to put on and take off, simple and elegant

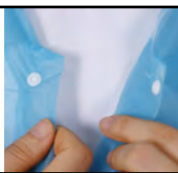

**03**  
**Cuff Design**  
Fits the wrist, not tight or loose



**04**  
**PP Fabric**  
Thick and tear-resistant, water-repellent, oil-proof and breathable



### ►Applications



## SMS Button Workwear

### ►Features

- Designed with thickened breathable fabric with reusable buttons.
- Made of spunbond layer and meltblown layer, the outer layer is wear-resistant and scratch-resistant, and has good breathability, making it dry and not stuffy to wear.

Model	Fabric	Properties	Main material	Uses
PNC-05	PP40g single collar button model	Dustproof, isolate pollutants	Non-woven fabrics	Maintain the cleanliness of the environment

### ►Details display

**01**  
**Neckline Design**  
Three-dimensional, beautiful and practical

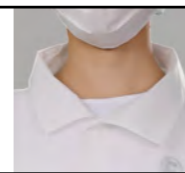

**02**  
**Buttons**  
Easy to put on and take off, simple and elegant

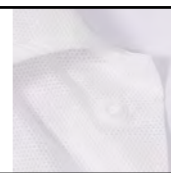

**03**  
**Cuff Design**  
Knitted cuffs fit the wrists comfortably without being tight



**04**  
**Pocket Design**  
Double side pockets for easy storage



### ►Applications



## SMS Knitted Collar Workwear

### ►Features

- The collar is made of knitted material, soft and skin-friendly, fits the neck, has good elasticity
- Designed with thickened breathable fabric with reusable buttons.
- It is composed of a spunbond layer and a meltblown layer.

Model	Fabric	Properties	Main material	Uses
PNC-04	30g knitted collar button	Dustproof, isolate pollutants	Non-woven fabrics	Maintain the cleanliness of the environment

### ►Details display

**01**  
**Neckline Design**  
SMS extra thick knitted round neck, three-dimensional lapel, simple and stylish

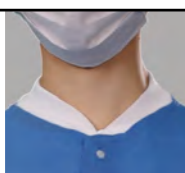

**02**  
**Buttons**  
Easy to put on and take off, simple and elegant

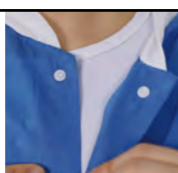

**03**  
**Cuff Design**  
Knitted cuffs fit the wrists comfortably without being tight



**04**  
**Pocket Design**  
Double side pockets for easy storage

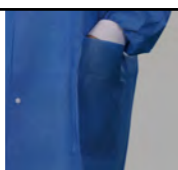

### ►Applications

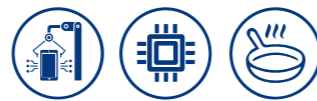

## SMS Velcro Workwear

### ►Features

- Designed with thickened breathable fabric with reusable buttons.
- Made of spunbond layer and meltblown layer, the outer layer is wear-resistant and scratch-resistant, and has good breathability, making it dry and not stuffy to wear.

Model	Fabric	Properties	Main material	Uses
PNC-06	40g single collar button model	Dustproof, isolate pollutants	Non-woven fabrics	Maintain the cleanliness of the environment

### ►Details display

**01**  
**Neckline Design**  
Three-dimensional, beautiful and practical



**02**  
**Velcro**  
Double-sided adhesive, not easy to fall off and easy to wear

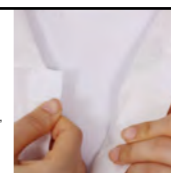

**03**  
**Cuff Design**  
Knitted cuffs fit the wrists comfortably without being tight



**04**  
**Pocket Design**  
Double side pockets for easy storage



### ►Applications

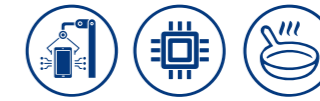

## Disposable Protective Cap

### ► Features

- The hat is designed to fit the curves of the head, tightly wrapping the hair and effectively preventing hair from being exposed and preventing hair, dandruff, and other debris from getting into the work environment.

Product name	Model	Material	Color	Uses
Strip cap (single rib)	DP-01	High quality non-woven fabric	Blue, White	New energy, biopharmaceuticals, semiconductors
Mesh cap	DP-02	Polyester-cotton and mesh	White, Yellow, Dark Blue, Bright red, Light blue, Pink, Orange	Food industry
Doctor cap	DP-03	SMS nonwoven/PP	Blue	Biopharmaceuticals
Strip cap (single rib)	DP-04	High quality non-woven fabric	blue, white, light yellow	New energy, biopharmaceuticals, semiconductors



### ► Applications



## Anti-static Shoes Cover

### ► Features

- Made of special anti-static material, it can quickly guide the human body to generate static charge to avoid the accumulation of static electricity.
- Can effectively block sole dust, hair, debris, etc. from entering specific areas, and keep clean spaces clean.



Model	Specification	Package
ASC-001	35g, regular, blue	100 pairs/pack, 2000 pairs/box (20 packs/box)



### ► Applications



## Disposable Shoe Covers

### ► Features

- Non-woven shoe covers are made of new environmentally friendly materials, this non-woven printed shoe cover is non-slip, practical and beautiful
- Highly elastic rubber band makes shoe covers more comfortable to wear



Model	Specification	Package
MSC-001	2.5 g, regular, blue	100 pairs/pack, 20 packs/box
MSC-002	black conductive, fabric 35g	100 pairs/pack, 20 packs/box
MSC-003	woven extended shoe cover, 49 * 14cm, blue	100 pairs/pack, 20 packs/box
MSC-004	non-woven shoe cover, thickened, 35g, blue	100 pairs/pack, 20 packs/box



### ► Applications



## Semi-coated Shoe Covers

### ► Features

- Made of PP and CPE composite materials, high-quality, and extremely wear-resistant.
- Thickened, non-slip sole; breathable and comfortable upper.
- Elastic bands with high-quality elastic cuffs.



Product Specifications	Color	Material	Package
15*40	Blue and white	PP+PE	50 pieces/pack, 1000 pieces/box



### ► Applications



## Disposable Non-woven Beard Cover

### ► Features

- Made of non-woven fabric, lightweight and breathable.
- Enhances comfort and breathability without compromising aesthetics.
- Safe for direct skin contact, comfortable and durable.
- Effectively blocks lint, stubble, and dust.



Size	Color	Material	Package
18-inch	Blue / white	Medical polypropylene non-stick PP non-woven fabric	100 pieces/pack



### ► Applications



## Breathable Film Strip Protective Clothing

### ► Features

- One-piece protective clothing With foot cover.
- Secondary virus isolation suit, second-class medical equipment, protect the whole body.
- Provide barrier protection for clinical medical staff fluids is not a risk in contact with infectious blood/body fluids/secretions at work.

Material	Size	Colour	Package
Non-woven fabric+PE film	M/L/XL/XXL/XXXL	White+blue strip	1 per bag, 50 per case



### ► Detail



## Breathable Film Strip Protective Clothing

### ► Features

- One-piece protective clothing (With foot cover).
- Secondary virus isolation suit, second-class medical equipment, protect the whole body.
- Provide barrier protection for clinical medical staff fluids is not a risk in contact with infectious blood/body fluids/secretions at work.

Material	Size	Colour	Package
Non-woven fabric+PE film	M/L/XL/XXL/XXXL	White+blue strip	1 per bag, 50 per case



### ► Detail



## Breathable Film Protective Clothing

### ►Features

- Harmless, liquid resistant, breathable microporous film material.
- Solid particle protective layer, can resist most Light chemical and acidic substances have a hat,a zipper on the front,no pockets,Wrists,ankles and waist.
- With elastic band Type 5/6.
- Suitable for environments that do not require contact with blood and or body fluids.

Size	Colour	Package
ML/XL/XXL/XXXL	White	1per bag,50per case



### ►Detail



## Protective Clothing

### ►Features

- Made of soft and transparent SBPP material.
- With hood, zipped front, no pockets and elasticated at wrists, ankles and waist,With foot cover.
- For greater protection, our Superior coveralls are liquid repellent and resist most lightchemicals and acids.

Material	Size	Colour	Package
Transparent SBPP	ML/XL/XXL/XXXL	white/blue/Navy blue	1per bag,50per case



### ►Detail



## Protective Clothing

### ►Features

- Made of soft and transparent SBPP material.
- With hood, zipped front, no pockets and elasticated at wrists, ankles and waist.
- For greater protection, our Superior coveralls are liquid repellent and resist most lightchemicals and acids.

Material	Size	Colour	Package
Transparent SBPP	ML/XL/XXL/XXXL	white/blue/Navy blue	1per bag,50per case



### ►Detail



## Protective Clothing

### ►Features

- Made of soft and transparent SBPP material.
- With hood, zipped front, no pockets and elasticated at wrists, ankles and waist.
- For greater protection, our Superior coveralls are liquid repellent and resist most lightchemicals and acids.

Material	Size	Colour	Package
Transparent SBPP	ML/XL/XXL/XXXL	white/blue/Navy blue	1per bag,50per case



### ►Detail



# Swabs for Clean Rooms



Depending on the specific cleaning needs, there are various types of swabs available, including PU sponge heads, polyester heads, non-woven heads, and cotton heads with paper handles. Manufactured using advanced production techniques and rigorous inspection processes, these swabs do not generate particles, impurities, or residue during use, ensuring precision and stability in cleaning operations. They are particularly suitable for cleaning in confined spaces.

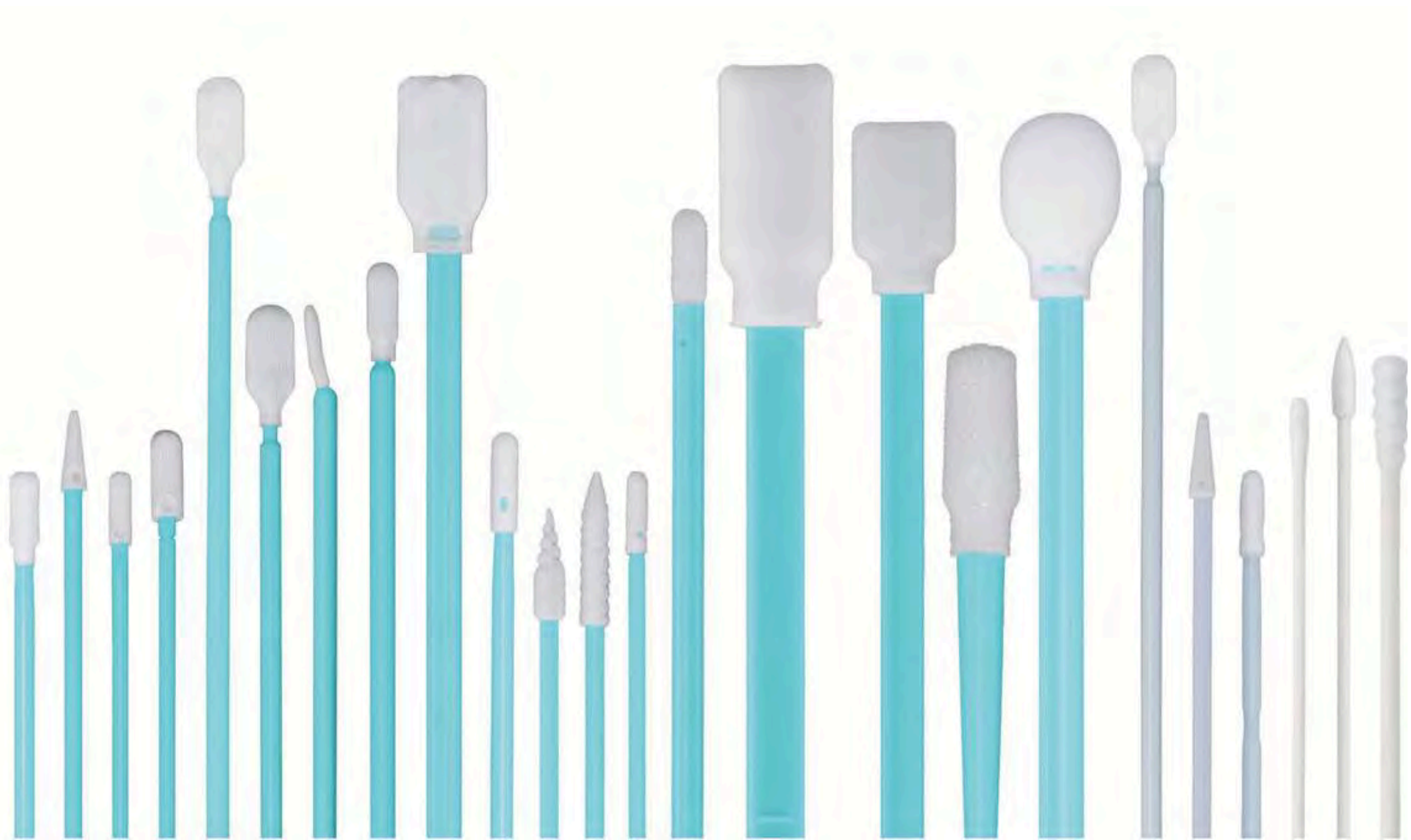

## Swab Series for Rooms Clean

Wide selection: Provides cleaning products suitable for requirements from Class 10 to Class 10,000 (ISO4 to ISO7).

**Polyester Swabs for Cleanrooms**  
**Foam Swabs for Cleanrooms**

Applications:

Glassware, laboratory research, semiconductors, LCDs, optics, microelectronics and biopharmaceutical industries.

## Swabs for Cleanrooms

The thermally bonded construction reduces the risk of particle generation during use. Our efficient, high-end processes minimize non-volatile residues (NVR) and ions from the swab. Cleanroom-specific packaging ensures the absence of silicone and amino compounds in the swab, a critical requirement in the electronics industry. I vonne, please let me know if you need to include this information or take any further action.



### Polyester Swabs for Cleanrooms



**KTRXWPS743**

Long Head	Header Width	Handle Width
11.6 mm	4.4 mm	Ø2.8 mm
Total Length of Swab	Material	Packing
68.8 mm	Polyester + PP	100 swabs/pack



**KTRXWPS750**

Long Head	Header Width	Handle Width
11.0 mm	3.6 mm	Ø2.4 mm
Total Length of Swab	Material	Packing
77.8 mm	Polyester + PP	100 swabs/pack



**KTRXWPS758**

Head Length	Header Width	Handle Width
10.0 mm	3.1 mm	Ø 2.3 mm
Total length of swab	Material	Packing
69.8 mm	Polyester + PP	100 swabs/pack



**KTRXWPS864**

Head Length	Header Width	Handle Width
11.2 mm	3.5 mm	Ø 2.8 mm
Total length of swab	Material	Packing
72.1 mm	Polyester + PP	100 swabs/pack



**KTRXWPS7002-12**

Head Length	Header Width	Handle Width
11.5 mm	4.2 mm	Ø 2.2 mm
Total length of swab	Material	Packing
70.6 mm	Polyester + PP	100 swabs/pack



**KTRXWPS740**

Head Length	Header Width	Handle Width
16.5 mm	7.0 mm	Ø 3.1 mm
Total length of swab	Material	Packing
162.0 mm	Polyester + PP	100 swabs/pack



**KTRXWPS741**

Head Length	Header Width	Handle Width
17.0 mm	7.0 mm	Ø 3.0 mm
Total length of swab	Material	Packing
92.5 mm	Polyester + PP	100 swabs/pack



**KTRXWPS761**

Head Length	Header Width	Handle Width
11.0 mm	3.6 mm	Ø 3.1 mm
Total length of swab	Material	Packing
90.5 mm	Polyester + PP	100 swabs/pack

### Polyester Swabs for Cleanrooms



**KTRXWPS1001**

Head Length	Header Width	Handle Width
13.5 mm	4.4 mm	Ø 4.0 mm
Total length of swab	Material	Packing
100.0 mm	Polyester + PP	100 swabs/pack



**KTRXWPS1002**

Head Length	Header Width	Handle Width
13.9 mm	4.5 mm	Ø 3.7 mm
Total length of swab	Material	Packing
99.3 mm	Polyester + PP	100 swabs/pack



**KTRXWPS712**

Head Length	Header Width	Handle Width
25.5 mm	13.0 mm	5.0 mm
Total length of swab	Material	Packing
127.0 mm	Polyester + PP	100 swabs/pack



**KTRXWPS712A**

Head Length	Header Width	Handle Width
25.5 mm	13.0 mm	5.0 mm
Total length of swab	Material	Packing
127.0 mm	Polyester + PP	100 swabs/pack



**KTRXWPS712C**

Head Length	Header Width	Handle Width
25.0 mm		5.0 mm
Total length of swab	Material	Packing
151.0 mm	Polyester + PP	100 swabs/pack

### Hyssop Polyester sheets for cleanrooms



**KTRXWFS742**

Head Length	Header Width	Handle Width
12.7 mm	3.8 mm	Ø 2.8 mm
Total length of swab	Material	Packing
69.2 mm	PU + PP	100 swabs/pack



**KTRXWFS742**

Head Length	Header Width	Handle Width
12.5 mm	3.8 mm	Ø 2.8 mm
Total length of swab	Material	Packing
75.0 mm	PU + PP	100 swabs/pack



**KTRXWFS742A**

Head Length	Header Width	Handle Width
12.5 mm	3.8 mm	Ø 2.7 mm
Total length of swab	Material	Packing
68.9 mm	PU + PP	100 swabs/pack



**KTRXWFS750**

Head Length	Header Width	Handle Width
11.6 mm	3.5 mm	Ø 2.4 mm
Total length of swab	Material	Packing
77.3 mm	PU + PP	100 swabs/pack

## Foam Swabs for Cleanrooms

## Foam Swabs for Cleanrooms



**KTRXWFS750**

Head Length	Header Width	Handle Width
11.0 mm	3.4 mm	Ø 2.4 mm
Total length of swab	Material	Packing
74.7 mm	PU + PP	100 swabs/pack



**KTRXWFS751**

Head Length	Header Width	Handle Width
15.0 mm	3.5 mm	Ø 2.5 mm
Total length of swab	Material	Packing
64.8 mm	PU + PP	100 swabs/pack



**KTRXWFS741**

Head Length	Header Width	Handle Width
17.5 mm	6.5 mm	Ø 3.0 mm
Total length of swab	Material	Packing
93.5 mm	PU + PP	100 swabs/pack



**KTRXWFS761**

Head Length	Header Width	Handle Width
11.3 mm	3.6 mm	Ø 3.1 mm
Total length of swab	Material	Packing
91.0 mm	PU + PP	100 swabs/pack



**KTRXWFS752**

Head Length	Header Width	Handle Width
21.0 mm	3.8 mm	Ø 2.5 mm
Total length of swab	Material	Packing
68.4 mm	PU + PP	100 swabs/pack



**KTRXWFS757**

Head Length	Header Width	Handle Width
11.0 mm	3.0 mm	Ø 2.3 mm
Total length of swab	Material	Packing
67.5 mm	PU + PP	100 swabs/pack



**KTRXWFS1001**

Head Length	Header Width	Handle Width
13.5 mm	4.3 mm	Ø 4.0 mm
Total length of swab	Material	Packing
100.0 mm	PU + PP	100 swabs/pack



**KTRXWFS1002**

Head Length	Header Width	Handle Width
14.0 mm	4.2 mm	Ø 3.7 mm
Total length of swab	Material	Packing
99.2 mm	PU + PP	100 swabs/pack



**KTRXWFS758**

Head Length	Header Width	Handle Width
11.5 mm	3.8 mm	Ø 2.3 mm
Total length of swab	Material	Packing
68.4 mm	PU + PP	100 swabs/pack



**KTRXWFS854**

Head Length	Header Width	Handle Width
11.4 mm	3.4 mm	Ø 2.8 mm
Total length of swab	Material	Packing
72.4 mm	PU + PP	100 swabs/pack



**KTRXWFS703**

Head Length	Header Width	Handle Width
40.0 mm	18.0 mm	8.8 mm
Total length of swab	Material	Packing
180.0 mm	PU + PP	50 swabs/pack



**KTRXWFS706**

Head Length	Header Width	Handle Width
27.0 mm	10.0 mm	Ø 3.2 mm
Total length of swab	Material	Packing
80.5 mm	PU + PP	50 swabs/pack



**KTRXWFS740**

Head Length	Header Width	Handle Width
17.5 mm	6.5 mm	Ø 3.1 mm
Total length of swab	Material	Packing
162.0 mm	PU + PP	100 swabs/pack



**KTRXWFS740C**

Head Length	Header Width	Handle Width
18.0 mm	6.5 mm	Ø 3.1 mm
Total length of swab	Material	Packing
316.5 mm	PU + PP	100 swabs/pack



**KTRXWFS707**

Head Length	Header Width	Handle Width
26.0 mm	16.0 mm	6.6 mm
Total length of swab	Material	Packing
130.0 mm	PU + PP	50 swabs/pack



**KTRXWFS708**

Head Length	Header Width	Handle Width
27.5 mm	19.0 mm	6.5 mm
Total length of swab	Material	Packing
125.5 mm	PU + PP	50 swabs/pack



**KTRXWFS742B**

Head Length	Header Width	Handle Width
12.5 mm	3.8 mm	Ø 2.8 mm
Total length of swab	Material	Packing
105.3 mm	PU + PP	100 swabs/pack



**KTRXWFS709**

Head Length	Header Width	Handle Width
12.5 mm	5.0 mm	Ø 4.3 mm
Total length of swab	Material	Packing
105.0 mm	PU + PP	100 swabs/pack



**KTRXWFS712**

Head Length	Header Width	Handle Width
25.5 mm	13.0 mm	5.0 mm
Total length of swab	Material	Packing
128.0 mm	PU + PP	50 swabs/pack



**KTRXWFS712C**

Head Length	Header Width	Handle Width
25.5 mm	12.5 mm	5.0 mm
Total length of swab	Material	Packing
152.0 mm	PU + PP	50 swabs/pack

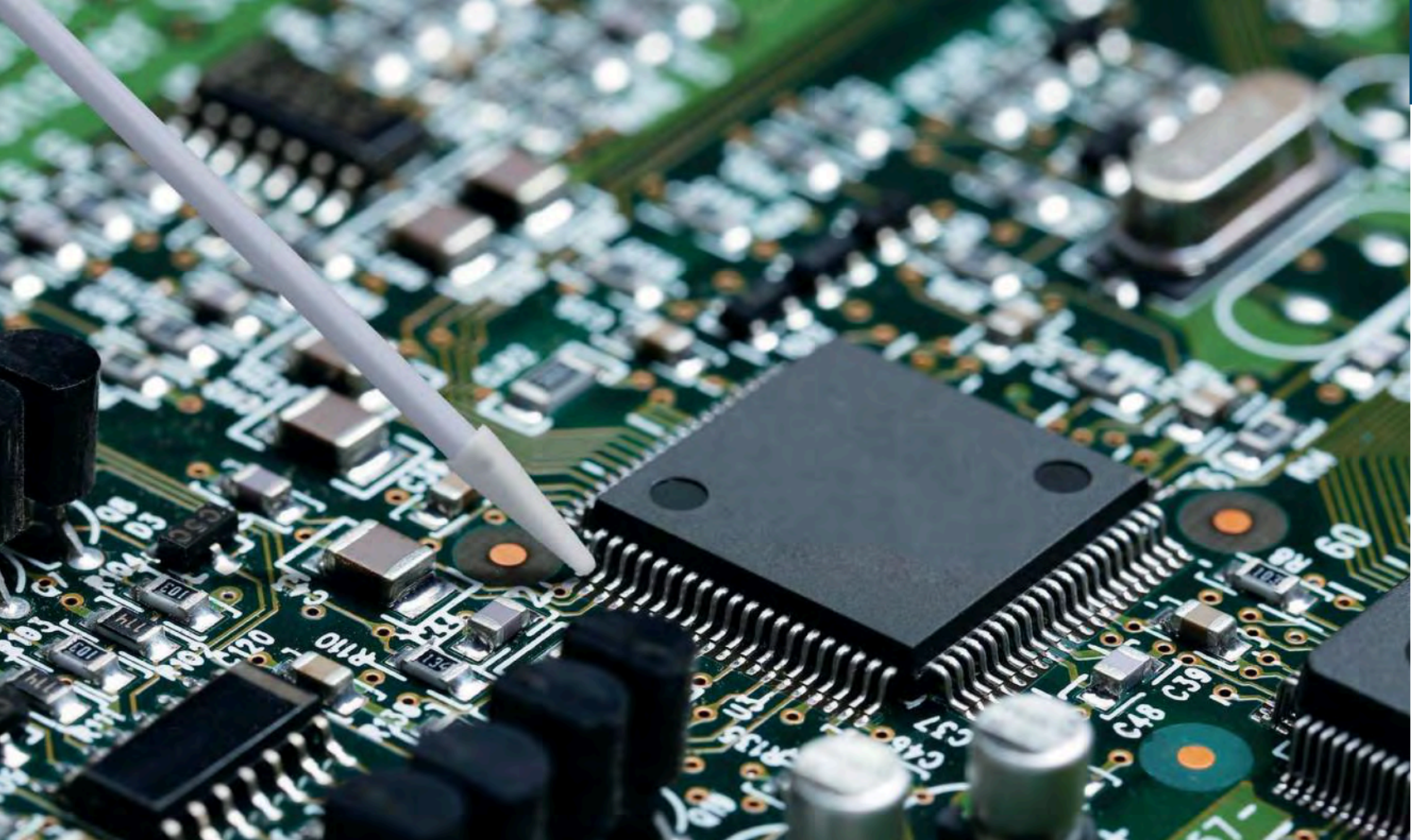

# Swab Series Antistatic for Clean Rooms

It effectively prevents static electricity generation during cleaning.

## Applications:

1. Medical devices
2. Microelectronics
3. Optics
4. Semiconductors and other related industries

## ESD swabs for Clean Rooms

The ESD swab for cleanrooms features an ESD handle that provides protection for products or environments sensitive to electrostatic discharge (ESD). These swabs have a very low level of contamination, ensuring that no contamination is transferred to the surface during use. The thermally bonded head effectively reduces the risk of adhesive contamination.



### Foam Swabs for Cleanrooms



KTRXWEPS740		
Head Length	Header Width	Handle Width
17.0 mm	7.0 mm	Ø 3.1 mm
Total length of swab	Material	Packing
164.0 mm	PU + PP	100 swabs/pack

### ESD Foam Swabs for Cleanrooms



KTRXWEFSD742		
Head Length	Header Width	Handle Width
12.5 mm	3.8 mm	Ø 2.9 mm
Total length of swab	Material	Packing
75.0 mm	PU + PP	100 swabs/pack



KTRXWEFS750		
Head Length	Header Width	Handle Width
11.6 mm	3.5 mm	Ø 2.5 mm
Total length of swab	Material	Packing
77.3 mm	PU + PP	100 swabs/pack



KTRXWEFSD750		
Head Length	Header Width	Handle Width
11.0 mm	3.4 mm	Ø 2.5 mm
Total length of swab	Material	Packing
74.7 mm	PU + PP	100 swabs/pack



KTRXWEFS752		
Head Length	Header Width	Handle Width
21.0 mm	3.8 mm	Ø 2.5 mm
Total length of swab	Material	Packing
68.4 mm	PU + PP	100 swabs/pack



KTRXWEFS740		
Head Length	Header Width	Handle Width
17.5 mm	6.5 mm	Ø 3.1 mm
Total length of swab	Material	Packing
164.0 mm	PU + PP	100 swabs/pack



## TOC Cleaning Validation Swabs

The TOC cleaning validation swab is widely used in the cleaning validation process in the biopharmaceutical industry. Using these swabs, samples can be collected and sent to the laboratory for analysis. By comparing the TOC level in the sample to a predefined standard, it is possible to determine the cleanliness of the sampled environment and verify whether it meets established requirements.



KTRXWTCPS740		
Head Length	Header Width	Handle Width
16.5 mm	7.0 mm	Ø 3.1 mm
Total length of swab	Material	Packing
162.0 mm	Polyester + PP	10 swabs/pack



KTRXWTCPS712A		
Head Length	Header Width	Handle Width
25.5 mm	13.0 mm	5 mm
Total length of swab	Material	Packing
127.0 mm	Polyester + PP	10 swabs/pack



KTRXWTCPS712C		
Head Length	Header Width	Handle Width
25.0 mm	13.0 mm	5 mm
Total length of swab	Material	Packing
151.0 mm	Polyester + PP	10 swabs/pack

# Swab Series for Validation TOC Cleaning in the Quarterfinals Clean

Suitable for cleanliness verification in applications with low total organic carbon (TOC) content

### Applications:

1. Biopharmaceutical cleaning validation
2. Validation of medical device cleaning
3. Guarantee of accuracy in laboratory experiments and other related fields



# Swab Series Cotton

First choice for precision instrument maintenance

- Applications:**
1. Precision instruments
  2. Optics
  3. Optoelectronics
  4. Circuit industries integrated (IC)
  5. Etc.

## Cotton Swab Series

Made from 100% pure cotton, our industrial cotton swabs offer excellent absorbency and produce less fiber and lint. The wide range of swabs can be used in various cleaning scenarios.  
Note: Swabs have a size tolerance, which is a normal phenomenon.



**KTRXWDO02**

Head Length	Header Width	Handle Width
12.0 mm	3.2 mm	Ø 1.5 mm
Total length of swab	Material	Packing
76.5 mm	Absorbent cotton	25 swabs/pack

**KTRXWB002**

Head Length	Header Width	Handle Width
13.5 mm	2.6 mm	Ø 1.5 mm
Total length of swab	Material	Packing
75.5 mm	Absorbent cotton	25 swabs/pack

**KTRXWA003**

Head Length	Header Width	Handle Width
11.2 mm	4.6 mm	Ø 2.3 mm
Total length of swab	Material	Packing
81.0 mm	Absorbent cotton	25 swabs/pack

**KTRXWB003**

Head Length	Header Width	Handle Width
11.0 mm	3.0 mm	Ø 1.5 mm
Total length of swab	Material	Packing
81.0 mm	Absorbent cotton	25 swabs/pack

**KTRXWD001**

Head Length	Header Width	Handle Width
14.5 mm	4.4 mm	Ø 2.3 mm
Total length of swab	Material	Packing
76.0 mm	Absorbent cotton	25 swabs/pack

**KTRXWA002**

Head Length	Header Width	Handle Width
14.5 mm	4.4 mm	Ø 2.3 mm
Total length of swab	Material	Packing
77.5 mm	Absorbent cotton	25 swabs/pack

**KTRXWB013**

Head Length	Header Width	Handle Width
8.5 mm	2.3 mm	Ø 1.4 mm
Total length of swab	Material	Packing
76.0 mm	Absorbent cotton	25 swabs/pack

**KTRXWB001**

Head Length	Header Width	Handle Width
13.5 mm	3.2 mm	Ø 1.5 mm
Total length of swab	Material	Packing
75.5 mm	Absorbent cotton	25 swabs/pack

# V O A D

I N T E R N A T I O N A L G R O U P

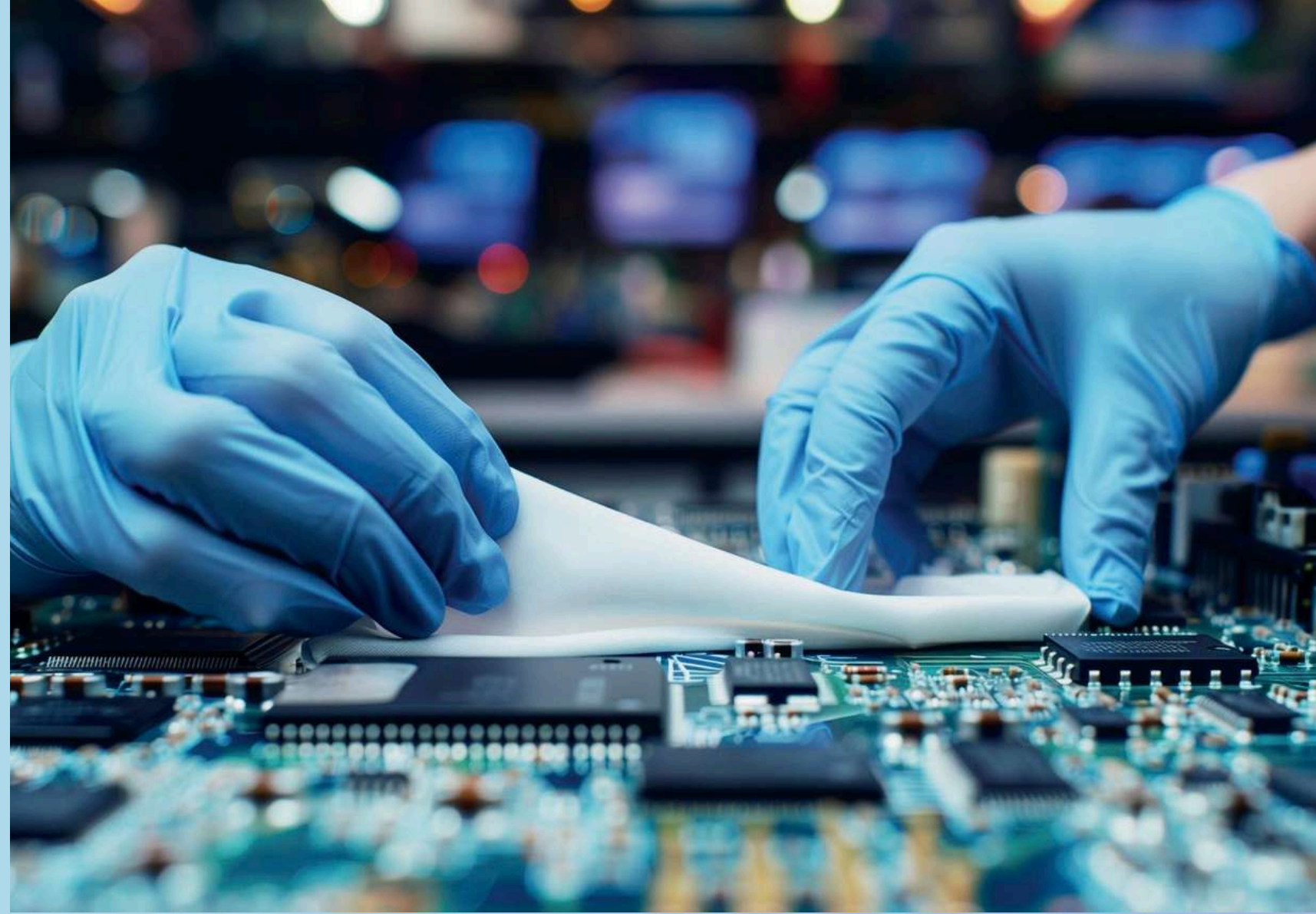

## Wipes Series for Clean Rooms

The ideal choice for cleaning needs in cleanroom environments.

Applications:

1. Manufacturing of electronic products
2. Manufacture of precision instruments
3. Pharmaceutical industry
4. Health sector



1. Polyester cleanroom wipes
2. Microfiber cleanroom wipes
3. Sub-ultra-fine cleanroom wipes
4. Padded wipes for clean rooms
5. Woven wipes for clean rooms
6. Non-woven microfiber wipes
7. Cleanroom wipe roll
8. Mesh wipes for cleanrooms
9. Non-woven wipes for cleanrooms

### Polyester wipes for cleanrooms ✨

Made with durable material, excellent stain removal capabilities, and a high level of cleaning power, polyester cleanroom wipes are ideal for critical environments. They are widely used for cleaning surface contamination and spills. They are an effective way to remove contaminants, liquids, and residue from surfaces. Different cleanroom environments require varying levels of cleanliness. All wipes meet low levels of APC, LPC, NVR, FTIR, and other contamination tests to ensure superior cleaning, consistent quality, and high performance.



Name of the Product	Model of the Product	Color	Base Weight	Size	Packing	Description of Product
Wipes Polyester for Clean Rooms	WP3107	White	110gsm	4"x4" (10x10cm)	600 sheets/package; 10 packs/box	Double fabric with edge sealed by laser
Wipes Polyester for Clean Rooms	WP3207	White	110gsm	6"x6" (15x15cm)	300 sheets/package; 10 packs/box	Double fabric with edge sealed by laser
Wipes Polyester for Clean Rooms	WP3307	White	110gsm	9"x9" (23x23cm)	150 sheets/package; 10 packs/box	Double fabric with edge sealed by laser
Wipes Polyester for Clean Rooms	WP3407	White	110gsm	12"x12" (31x31cm)	150 sheets/package; 10 packs/box	Double fabric with edge sealed by laser

## Product Specifications: Polyester wipes for cleanroom use

Model of the Product	Color	Base Weight	Size	Packing	Product Description
WP3101	White	120gsm	4" × 4" (10×10cm)	600 sheets/pack; 10 packs/box 300	Plain weave with laser-sealed edge
WP3201	White	120gsm	6" × 6" (15×15cm)	sheets/pack; 10 packs/box	
WP3301	White	120gsm	9" × 9" (23×23cm)	150 sheets/pack; 10 packs/box 150	Plain weave with laser-sealed edge
WP3401	White	120gsm	12" × 12" (31×31cm)	sheets/pack; 10 packs/box 600	Plain weave with laser-sealed edge
WP4101	White	120gsm	4" × 4" (10×10cm)	sheets/pack; 10 packs/box 300	Simple fabric with ultrasonically sealed edge
WP4201	White	120gsm	6" × 6" (15×15cm)	sheets/pack; 10 packs/box	Simple fabric with ultrasonically sealed edge
WP4301	White	120gsm	9" × 9" (23×23cm)	150 sheets/pack; 10 packs/box	Simple fabric with ultrasonically sealed edge
WP4401	White	120gsm	12" × 12" (31×31cm)		Simple fabric with ultrasonically sealed edge
WP2101	White	120gsm	4" × 4" (10×10cm)	600 sheets/pack; 10 packs/box 300	Double-knit fabric with heat-sealed edge.
WP2201	White	120gsm	6" × 6" (15×15cm)	sheets/pack; 10 packs/box	Double-sided with heat-sealed edge. Double-knitted.
WP2301	White	120gsm	9" × 9" (23×23cm)	150 sheets/pack; 10 packs/box	with heat-sealed edge. Double-knitted with
WP2401	White	120gsm	12" × 12" (31×31cm)		Heat-sealed edge. Double-knit with hem.
WP4104	White	120gsm	4" × 4" (10×10cm)	600 sheets/pack; 10 packs/box 300	Ultrasonic sealing. Double-layered fabric with border.
WP4204	White	120gsm	6" × 6" (15×15cm)	sheets/pack; 10 packs/box	Ultrasonic sealing. Double-layered fabric with border.
WP4304	White	120gsm	9" × 9" (23×23cm)	150 sheets/pack; 10 packs/box	Ultrasonic sealing. Double-layered fabric with border
WP4404	White	120gsm	12" × 12" (31×31cm)		Ultrasonic sealing. Plain weave with border.
WP3108	White	140gsm	4" × 4" (10×10cm)	600 sheets/pack; 10 packs/box 300	Laser sealed plain weave with sealed edge
WP3208	White	140gsm	6" × 6" (15×15cm)	sheets/pack; 10 packs/box	laser-sealed plain weave with sealed edge
WP3308	White	140gsm	9" × 9" (23×23cm)	150 sheets/pack; 10 packs/box	Laser-sealed plain weave fabric with laser-sealed edge
WP3408	White	140gsm	12" × 12" (31×31cm)		Double-knit fabric with heat-sealed edge.
WP2102	White	140gsm	4" × 4" (10×10cm)	600 sheets/pack; 10 packs/box 300	Double-sided with heat-sealed edge. Double-knitted.
WP2202	White	140gsm	6" × 6" (15×15cm)	sheets/pack; 10 packs/box	with heat-sealed edge. Double-knitted with
WP2302	White	140gsm	9" × 9" (23×23cm)	150 sheets/pack; 10 packs/box	Heat-sealed edge. Double-knit with hem.
WP2402	White	140gsm	12" × 12" (31×31cm)		Ultrasonic sealing. Double-layered fabric with border.
WP4102	White	140gsm	4" × 4" (10×10cm)	600 sheets/pack; 10 packs/box 300	Ultrasonic sealing. Double-layered fabric with border.
WP4202	White	140gsm	6" × 6" (15×15cm)	sheets/pack; 10 packs/box	Ultrasonic sealing. Double-layered fabric with border.
WP4302	White	140gsm	9" × 9" (23×23cm)	150 sheets/pack; 10 packs/box	Ultrasonic sealing and sealed edge
WP4402	White	140gsm	12" × 12" (31×31cm)		Double-layered fabric with ultrasonically sealed edge
WP5101	White	140gsm	4" × 4" (10×10cm)	600 sheets/pack; 10 packs/box	Double-layered fabric with ultrasonically sealed edge and sealed edge
WP5201	White	140gsm	6" × 6" (15×15cm)	300 sheets/pack; 10 packs/box	Double-layered fabric with ultrasonically sealed edge and sealed edge
WP5301	White	140gsm	9" × 9" (23×23cm)	150 sheets/pack; 10 packs/box	Double-layered fabric with ultrasonically sealed edge and sealed edge
WP5401	White	140gsm	12" × 12" (31×31cm)	150 sheets/pack; 10 packs/box	Double-layered fabric with ultrasonically sealed edge and sealed edge

Model of the Product	Color	Base Weight	Size	Packing	Product Description
WP3109	White	160gsm	4" × 4" (10×10cm)	600 sheets/pack; 10 packs/box	Plain weave with laser-sealed edge
WP3209	White	160gsm	6" × 6" (15×15cm)	300 sheets/pack; 10 packs/box	Plain weave with laser-sealed edge. Plain weave
WP3309	White	160gsm	9" × 9" (23×23cm)	150 sheets/pack; 10 packs/box	with laser-sealed edge. Plain weave with edge.
WP3409	White	160gsm	12" × 12" (31×31cm)	150 sheets/pack; 10 packs/box	Laser sealed double-layered fabric with laser-sealed edge
WP3110	White	160gsm	4" × 4" (10×10cm)	600 sheets/pack; 10 packs/box	Double-layered fabric with laser-sealed edge. Double-layered fabric with
WP3210	White	160gsm	6" × 6" (15×15cm)	300 sheets/pack; 10 packs/box	Laser-sealed edge. Double-layered fabric with sealed edge.
WP3310	White	160gsm	9" × 9" (23×23cm)	150 sheets/pack; 10 packs/box	Laser-sealed double-layer fabric with ultrasonic-sealed edge
WP3410	White	160gsm	12" × 12" (31×31cm)	150 sheets/pack; 10 packs/box	Double-layered fabric with ultrasonically sealed edge.
WP4107	White	160gsm	4" × 4" (10×10cm)	600 sheets/pack; 10 packs/box	Double-layered fabric with ultrasonically sealed edge.
WP4207	White	160gsm	6" × 6" (15×15cm)	300 sheets/pack; 10 packs/box	Ultrasonic sealed edge Double fabric with edge
WP4307	White	160gsm	9" × 9" (23×23cm)	150 sheets/pack; 10 packs/box	Ultrasonic sealing and sealed edge
WP4407	White	160gsm	12" × 12" (31×31cm)	150 sheets/pack; 10 packs/box	Double-layered fabric with ultrasonically sealed edge and sealed edge
WP5102	White	160gsm	4" × 4" (10×10cm)	600 sheets/pack; 10 packs/box	Double-layered fabric with ultrasonically sealed edge and sealed edge
WP5202	White	160gsm	6" × 6" (15×15cm)	300 sheets/pack; 10 packs/box	Double-layered fabric with ultrasonically sealed edge and sealed edge
WP5302	White	160gsm	9" × 9" (23×23cm)	150 sheets/pack; 10 packs/box	Plain weave with laser-sealed edge. Plain weave
WP5402	White	160gsm	12" × 12" (31×31cm)	150 sheets/pack; 10 packs/box	with laser-sealed edge. Plain weave with edge.
WP3111	White	180gsm	4" × 4" (10×10cm)	600 sheets/pack; 10 packs/box	Laser sealed. Plain weave fabric with laser-sealed edge.
WP3211	White	180gsm	6" × 6" (15×15cm)	300 sheets/pack; 10 packs/box	Laser-sealed double-layered fabric with laser-sealed edge.
WP3311	White	180gsm	9" × 9" (23×23cm)	150 sheets/pack; 10 packs/box	Double-sided fabric with laser-sealed edge
WP3411	White	180gsm	12" × 12" (31×31cm)	150 sheets/pack; 10 packs/box	Laser sealed double-layered fabric with laser-sealed edge
WP3112	White	180gsm	4" × 4" (10×10cm)	600 sheets/pack; 10 packs/box	8mm conductive fiber, double woven with laser-sealed edge
WP3212	White	180gsm	6" × 6" (15×15cm)	300 sheets/pack; 10 packs/box	8mm conductive fiber, double woven with laser-sealed edge
WP3312	White	180gsm	9" × 9" (23×23cm)	150 sheets/pack; 10 packs/box	8mm conductive fiber, double woven with laser-sealed edge
WP3412	White	180gsm	12" × 12" (31×31cm)	150 sheets/pack; 10 packs/box	8mm conductive fiber, double woven with laser-sealed edge
WP3102	White	120gsm	4" × 4" (10×10cm)	600 sheets/pack; 10 packs/box	
WP3202	White	120gsm	6" × 6" (15×15cm)	300 sheets/pack; 10 packs/box	
WP3302	White	120gsm	9" × 9" (23×23cm)	150 sheets/pack; 10 packs/box	
WP3402	White	120gsm	12" × 12" (31×31cm)	150 sheets/pack; 10 packs/box	

## Microfiber Wipes for Cleanrooms

With a high fiber density and soft material, these microfiber cleanroom wipes provide ample contact with product surfaces during cleaning. Solvents evaporate quickly after use, effectively preventing scratches when cleaning precision instruments and equipment. They also offer excellent removal of fingerprints, oil stains, ink, and dust.



Model of Product	Color	Base Weight	Size	Packing	Description of Product
WM3102	White	160 gsm	4"x4" (10x10 cm)	600 sheets/package; 10 packs/box	Edge sealed by laser
WM3202	White	160 gsm	6"x6" (15x15 cm)	300 sheets/package; 10 packs/box	Edge sealed by laser
WM3302	White	160 gsm	9"x9" (23x23 cm)	150 sheets/package; 10 packs/box	Edge sealed by laser
WM3402	White	160 gsm	12"x12" (31x31 cm)	150 sheets/package; 10 packs/box	Edge sealed by laser
WM4102	White	160 gsm	4"x4" (10x10 cm)	600 sheets/package; 10 packs/box	Sealed edge ultrasonic
WM4202	White	160 gsm	6"x6" (15x15 cm)	300 sheets/package; 10 packs/box	Sealed edge ultrasonic
WM4302	White	160 gsm	9"x9" (23x23 cm)	150 sheets/package; 10 packs/box	Sealed edge ultrasonic
WM4402	White	160 gsm	12"x12" (31x31 cm)	150 sheets/package; 10 packs/box	Sealed edge ultrasonic
WM3103	White	180 gsm	4"x4" (10x10 cm)	600 sheets/package; 10 packs/box	Edge sealed by laser
WM3203	White	180 gsm	6"x6" (15x15 cm)	300 sheets/package; 10 packs/box	Edge sealed by laser
WM3303	White	180 gsm	9"x9" (23x23 cm)	150 sheets/package; 10 packs/box	Edge sealed by laser
WM3403	White	180 gsm	12"x12" (31x31 cm)	150 sheets/package; 10 packs/box	Edge sealed by laser

Product Model	Color	Base Weight	Size	Packing	Description of products
WM2101	White	180 gsm	4"x4" (10x10 cm)	600 sheets/pack; 10 packages/box	Edge sealed by thermal cut-off
WM2201	White	180 gsm	6"x6" (15x15 cm)	300 sheets/pack; 10 packages/box	Edge sealed by thermal cut-off
WM2301	White	180 gsm	9"x9" (23x23 cm)	150 sheets/pack; 10 packages/box	Edge sealed by thermal cut-off
WM2401	White	180 gsm	12"x12" (31x31 cm)	150 sheets/pack; 10 packages/box	Edge sealed by thermal cut-off
WM3104	White	200 gsm	4"x4" (10x10 cm)	600 sheets/pack; 10 packages/box	Edge sealed by thermal cut-off
WM3204	White	200 gsm	6"x6" (15x15 cm)	300 sheets/pack; 10 packages/box	Laser-sealed edge
WM3304	White	200 gsm	9"x9" (23x23 cm)	150 sheets/pack; 10 packages/box	Laser-sealed edge
WM3404	White	200 gsm	12"x12" (31x31 cm)	150 sheets/pack; 10 packages/box	Laser sealed edge
WM3106	White	220 gsm	4"x4" (10x10 cm)	600 sheets/pack; 10 packages/box	ultrasonic
WM3206	White	220 gsm	6"x6" (15x15 cm)	300 sheets/pack; 10 packages/box	Sealed edge ultrasonic
WM3306	White	220 gsm	9"x9" (23x23 cm)	150 sheets/pack; 10 packages/box	Sealed edge ultrasonic
WM3406	White	220 gsm	12"x12" (31x31 cm)	150 sheets/pack; 10 packages/box	Sealed edge ultrasonic
WM4104	White	220 gsm	4"x4" (10x10 cm)	600 sheets/pack; 10 packages/box	Sealed edge ultrasonic
WM4204	White	220 gsm	6"x6" (15x15 cm)	300 sheets/pack; 10 packages/box	Sealed edge ultrasonic
WM4304	White	220 gsm	9"x9" (23x23 cm)	150 sheets/pack; 10 packages/box	Sealed edge ultrasonic
WM4404	White	220 gsm	12"x12" (31x31 cm)	150 sheets/pack; 10 packages/box	Sealed edge ultrasonic
WM5101	White	220 gsm	4"x4" (10x10 cm)	600 sheets/pack; 10 packages/box	Sealed edge ultrasonic
WM5201	White	220 gsm	6"x6" (15x15 cm)	300 sheets/pack; 10 packages/box	Sealed edge ultrasonic
WM5301	White	220 gsm	9"x9" (23x23 cm)	150 sheets/pack; 10 packages/box	Sealed edge ultrasonic
WM5401	White	220 gsm	12"x12" (31x31 cm)	150 sheets/pack; 10 packages/box	Sealed edge ultrasonic

## Woven Cleanroom Cloths

Using weaving techniques with smooth, twill, and mixed structures, it significantly improves the effectiveness of surface decontamination and cleaning. It stands out for removing dust, films, and adhesive residue from terminals without scratching the product surface during the cleaning process.



Model of Product	Color	Base Weight	Size	Packing	Description of Product
W5309	White	110 gsm	4"x4" (10x10 cm)	600 sheets/package; 10 packs/box	Edge sealed by laser
W5310	White	110 gsm	6"x6" (15x15 cm)	300 sheets/package; 10 packs/box	Edge sealed by laser
W5311	White	110 gsm	9"x9" (23x23 cm)	150 sheets/package; 10 packs/box	Edge sealed by laser
W5312	White	110 gsm	12"x12" (31x31 cm)	150 sheets/package; 10 packs/box	Edge sealed by laser
W5301	White	110 gsm	4"x4" (10x10 cm)	600 sheets/package; 10 packs/box	Sealed edge ultrasonic
W5302	White	110 gsm	6"x6" (15x15 cm)	300 sheets/package; 10 packs/box	Sealed edge ultrasonic
W5303	White	110 gsm	9"x9" (23x23 cm)	150 sheets/package; 10 packs/box	Sealed edge ultrasonic
W5304	White	110 gsm	12"x12" (31x31 cm)	150 sheets/package; 10 packs/box	Sealed edge ultrasonic
W5305	White	150 gsm	4"x4" (10x10 cm)	600 sheets/package; 10 packs/box	Ultrasonic edge sealed
W5306	White	150 gsm	6"x6" (15x15 cm)	300 sheets/package; 10 packs/box	Ultrasonic edge sealed
W5307	White	150 gsm	9"x9" (23x23 cm)	150 sheets/package; 10 packs/box	Ultrasonic edge sealed
W5308	White	150 gsm	12"x12" (31x31 cm)	150 sheets/package; 10 packs/box	Ultrasonic edge sealed

## Non-woven Microfiber Cloths

The placement of continuous filament fibers in a network formation provides a unique microfiber surface structure. This allows for complete contact with the surface being cleaned, facilitating dust attraction. When cleaning fluorescent substances, the smooth surface leaves no scratches or sheds fibers. The product has excellent water absorption and retention, performing even better when used with cleaning agents.



Model of Product	Color	Base Weight	Size	Packing	Description of Product
W5601	White	80 gsm	9"x9" (23x23 cm)	300 sheets/package; 10 packs/box	Edge cut with blade
W5602	White	80 gsm	12"x12" (31x31 cm)	100 sheets/package; 10 packs/box	Edge cut with blade

## Roll of Cleanroom Cloths

The material is soft and gentle, with a high capacity for removing contaminants. It effectively removes oil stains, ink, and dust particles, making it especially suitable for the COG process in the LCD industry.



Model of Product	Color	Base Weight	Size	Packing	Description of Product
W5101	White	180 gsm	Roll width: 10 mm; Roll length: 10-200 m	76.5 mm/51 mm	Sealed edge ultrasonic
W5109	White	220 gsm	Roll width: 250 mm; Roll length: 10-200 m	76.5 mm/51 mm	Edge sealed with heat

### Sub-ultra-thin Cleanroom Cloths

Using a tight weaving method not only improves the abrasion resistance of the cloths but also results in a soft, delicate texture that won't easily scratch products or shed fibers. It is especially suitable for cleaning and adhering to small LCD screens, offering high decontamination capacity.



Model of Product	Color	Base Weight	Size	Packing	Description of Product
WS3102	White	100 gsm	4"x4" (10x10 cm)	600 sheets/package; 10 packs/box	Edge sealed by laser
WS3202	White	100 gsm	6"x6" (15x15 cm)	300 sheets/package; 10 packs/box	Edge sealed by laser
WS3302	White	100 gsm	9"x9" (23x23 cm)	150 sheets/package; 10 packs/box	Edge sealed by laser
WS3402	White	100 gsm	12"x12" (31x31 cm)	150 sheets/package; 10 packs/box	Edge sealed by laser
WS2101	White	110 gsm	4"x4" (10x10 cm)	600 sheets/package; 10 packs/box	Edge sealed by thermal cut-off
WS2201	White	110 gsm	6"x6" (15x15 cm)	300 sheets/package; 10 packs/box	Edge sealed by thermal cut-off
WS2301	White	110 gsm	9"x9" (23x23 cm)	150 sheets/package; 10 packs/box	Edge sealed by thermal cut-off
WS2401	White	110 gsm	12"x12" (31x31 cm)	150 sheets/package; 10 packs/box	Edge sealed by thermal cut-off
WS4101	White	120 gsm	4"x4" (10x10 cm)	600 sheets/package; 10 packs/box	Sealed edge ultrasonic
WS4201	White	120 gsm	6"x6" (15x15 cm)	300 sheets/package; 10 packs/box	Sealed edge ultrasonic
WS4301	White	120 gsm	9"x9" (23x23 cm)	150 sheets/package; 10 packs/box	Sealed edge ultrasonic
WS4401	White	120 gsm	12"x12" (31x31 cm)	150 sheets/package; 10 packs/box	Sealed edge ultrasonic

### Sub-ultra-thin Cleanroom Cloths

Using ultrasonic technology, two layers of polyester fabric are firmly bonded with a clear ultrasonic embossing. It effectively removes dust and dirt, has excellent liquid absorption, and is thick and durable.



Model of Product	Color	Base Weight	Size	Packing	Product Description
W5221	White	240 gsm	4"x4" (10x10 cm)	300 sheets/pack; 8 packages/box	2-layer padded ultrasonic edge
W5222	White	240 gsm	6"x6" (15x15 cm)	200 sheets/pack; 10 packages/box	2-layer padded ultrasonic edge
W5223	White	240 gsm	9"x9" (23x23 cm)	100 sheets/pack; 10 packages/box	2-layer padded ultrasonic edge
W5224	White	240 gsm	12"x12" (31x31 cm)	100 sheets/pack; 6 packages/box	2-layer padded ultrasonic edge
W5213	White	220 gsm	4"x4" (10x10 cm)	300 sheets/pack; 8 packages/box	2-layer padded laser-sealed edge
W5214	White	220 gsm	6"x6" (15x15 cm)	200 sheets/pack; 10 packages/box	2-layer padded laser-sealed edge
W5215	White	220 gsm	9"x9" (23x23 cm)	100 sheets/pack; 10 packages/box	2-layer padded laser-sealed edge
W5216	White	220 gsm	12"x12" (31x31 cm)	100 sheets/pack; 6 packages/box	2-layer padded laser-sealed edge
W5217	White	240 gsm	4"x4" (10x10 cm)	300 sheets/pack; 8 packages/box	2-layer padded ultrasonic edge
W5218	White	240 gsm	6"x6" (15x15 cm)	200 sheets/pack; 10 packages/box	2-layer padded ultrasonic edge
W5219	White	240 gsm	9"x9" (23x23 cm)	100 sheets/pack; 10 packages/box	2-layer padded ultrasonic edge
W5220	White	240 gsm	12"x12" (31x31 cm)	100 sheets/pack; 6 packages/box	2-layer padded ultrasonic edge



# Cleaning Series for Machines SMT printing

Ideal for meeting the stencil cleaning needs of various brands and models of SMT printing machines.

## Applications

### SMT Stencil Cleaning Cloth:

For electronics factories that need to remove excess solder paste and red glue from stencils and circuit boards, keeping the latter impeccably clean. This significantly reduces waste rates, improving production efficiency and product quality. **Cleaning Cloth for Printing Machines** Suitable for the cleaning needs of

conventional models from major brands such as Heidelberg, Komori, and KBA.

## Series of Cleaning for SMT Printing Machines

SMT Stencil Cleaning Cloth:

Made from functional fibers such as wood cellulose and polyester, this cloth has excellent cleaning properties, strong dirt and oil absorption capacity, high overall absorbency, and does not shed particles or fibers. The core is composed of high-quality, high-strength materials that prevent it from easily deforming. This product can effectively clean the surface of delicate items; it is highly durable and breathable.

Printing Machine Cleaning Cloth: With high absorbency, low lint formation, high strength, and good solvent resistance, these cloths can quickly and thoroughly remove ink and solvents from rubber rollers without leaving any residue. The high-strength material prevents deformation under stretching during use, thus meeting the strict cleaning requirements of the printing industry.



Name of the Product	Product Model	Machine Model	Internal Diameter * Tube length	Width of Cloth	Cloth Length	Tube Type	Extremes of Core N/A
SMT Stencil Wiper	W6101	MPM	19.5*455 mm	250 mm	10 m	Core Plastic	N/A
SMT Stencil Wiper	W6102	MPM	19.5*455 mm	300 mm	10 m	Core Plastic	N/A
SMT Stencil Wiper	W6103	MPM	19.5*455 mm	330 mm	10 m	Core Plastic	N/A
SMT Stencil Wiper	W6104	MPM	19.5*455 mm	350 mm	10 m	Core Plastic	N/A
SMT Stencil Wiper	W6105	MPM	19.5*455 mm	400 mm	10 m	Core Plastic	Internal slot
SMT Stencil Wiper	W6106	DEK	20*530 mm	250 mm	10 m	Non Plastic	both ends or an extreme Internal slot
SMT Stencil Wiper	W6107	DEK	20*530 mm	300 mm	10 m	Non Plastic	both ends or an extreme Internal slot
SMT Stencil Wiper	W6108	DEK	20*530 mm	400 mm	10 m	Non Plastic	both ends or an extreme Internal slot
SMT Stencil Wiper	W6109	DEK	20*530 mm	490 mm	10 m	Non Plastic	both ends or an extreme Internal slot
SMT Stencil Wiper	W6110	DEK	20*530 mm	500 mm	10 m	Non Plastic	both ends or an extreme Internal slot
SMT Stencil Wiper	W6111	DEK	20*530 mm	510 mm	10 m	Core Plastic	both ends or an extreme Internal slot
SMT Stencil Wiper	W6112	GKG	20*410 mm	400 mm	10 m	Core Plastic	Core with 4 internal slots
SMT Stencil Wiper	W6113	EKRA	13.5*400 mm	300 mm	10 m	Core Plastic	Internal slot both ends
SMT Stencil Wiper	W6114	EKRA	13.5*400 mm	400 mm	10 m	Core Plastic	Internal slot both ends
SMT Stencil Wiper	W6115	SONY	20*280 mm	260 mm	20 m	Core Plastic	Internal slot both ends
SMT Stencil Wiper	W6116	HITACHI	30*360 mm	300 mm	10 m	Core Plastic	N/A
SMT Stencil Wiper	W6117	PANASONIC	38*350 mm	350 mm	10 m	Core Plastic	N/A
SMT Stencil Wiper	W6118	YAMAHA	25.5*360 mm	350 mm	10 m	Core Plastic	N/A
SMT Stencil Wiper	W6119	YAMAHA	25.5*420 mm	400 mm	10 m	Core Plastic	N/A
SMT Stencil Wiper	W6120	KME	38*480 mm	480 mm	20 m	Core Plastic	N/A

Name of the Product	Product Model	Machine Model	Internal Diameter * Tube length	Cloth Width	Cloth Length	Tube Type	Extremes of Core
SMT Stencil Wiper	W6121	MINAMI	8*290 mm	270 mm	10 m	Core Plastic	Internal slot both ends
SMT Stencil Wiper	W6122	MINAMI	8*410 mm	350 mm	10 m	Core Plastic	Internal slot both ends
SMT Stencil Wiper	W6123	DESEN	20*410 mm	300 mm	10 m	Core Plastic	Internal slot both ends
SMT Stencil Wiper	W6124	JUKI	38*270 mm	260 mm	15 m	Core Plastic	N/A
SMT Stencil Wiper	W6125	JUKI	38*353 mm	345 mm	15 m	Core Plastic	N/A

Name of the Product	Product Model	Machine Model	Specification	Cloth Length	Color	Name of the Product	Product Model
Printing Machine Cleaning Wiper	W6201	DESEN SM-52	Core (mm): 2010802 . 5, Spec:20mm*1070mm	12 m	White	Printing Machine Cleaning Wiper	W6201
Printing Machine Cleaning Wiper	W6202	DESEN102	Core (mm): 2010882 . 5, Spec:20mm*1078mm	12 m	Blue	Printing Machine Cleaning Wiper	W6202
Printing Machine Cleaning Wiper	W6203	DESEN XL-105	Core (mm): 32.5105 43, Spec:32.5mm*1054mm	13.5 m	Blue Lake	Printing Machine Cleaning Wiper	W6203



# Cloths of High-Quality Cleaning Resistance for Oil

High oil absorption capacity, compatible with most solvents

## Applications:

1. Production and maintenance of bearings, gears and other transmissions.
2. Manufacturing and maintenance of transport equipment.
3. Coating production, inks, pigments and other materials.
4. Printing industry and other industries.

## Cloths of Cleaning of High Oil Resistance

Made from meltblown polypropylene, a new material capable of rapidly absorbing several times its own weight in oil. It provides excellent oil removal capabilities without leaving lint on the cleaned surface. This material remains strong even when wet, allowing for washing and reuse. Furthermore, it exhibits high solvent resistance, enhancing its cleaning effectiveness when used with solvents.



## Product Specifications

Product Name	Model of the Product	Color	Size	Packing	Texture	Material
Lint-free oil-absorbent cloth	W4101	White	30x30 cm	50 pieces/pack, 10 packages/box	Quilted design simple point	100% PP
Lint-free oil-absorbent cloth	W4301	White	30x30 cm	100 pieces/pack, 5 packages/box	Padded design star type	100% PP
Heavy-duty oil-absorbing cloth	W4202	Blue	24.9x30 cm	717 pieces/roll/box	Bark	100% PP
Heavy-duty oil-absorbing cloth	W4204	Blue	30x30 cm	Folded in quarters; 66 pieces/package, 8 packages/box	Bark	100% PP



# Cleaning Cloth Series

## Multipurpose

Low lint shedding, durable, meets multiple cleaning requirements. Applications:

1. Manufacturing and maintenance of transport equipment such as automobiles, rail transport, aviation, etc.
2. Production of paints, inks, pigments, etc.
3. Food processing
4. Manufacturing and maintenance of gears, bearings and transmission equipment
5. Manufacturing and maintenance of equipment for power plants and other industries

### Multipurpose Cloth Series

This series of cloths offers excellent absorbency with minimal lint and residue shedding, allowing for quick and efficient surface cleaning. Their high resistance in both dry and wet conditions enables effective cleaning even on rough surfaces. Compatible with solvents, they meet a wide variety of daily cleaning needs, significantly increasing productivity. Manufactured under strict standards, they are safe and hygienic, free of heavy metals and harmful bacteria.



### Product Specifications

Name of the Product	Product Model	Color	Size	Packing	Material
Multipurpose Cloth	W1101	White	25×35 cm	300 pieces/box, 6 boxes/case	Cellulose Polyester
	W1102	White	30×35 cm	300 pieces/box, 6 boxes/case	Cellulose Polyester
	W1103	White	25×38 cm	500 pieces/roll, 4 rolls/case	Cellulose Polyester
	W1301	Blue	25×35 cm	300 pieces/box, 6 boxes/case	Cellulose Polyester
	W1302	Blue	23×34 cm	500 pieces/roll, 2 rolls/case	Cellulose Polyester
	W1501	Green	25×35 cm	300 pieces/box, 6 boxes/case	Cellulose Polyester
	W1502	Green	20×38 cm	500 pieces/roll, 4 rolls/case	Cellulose Polyester

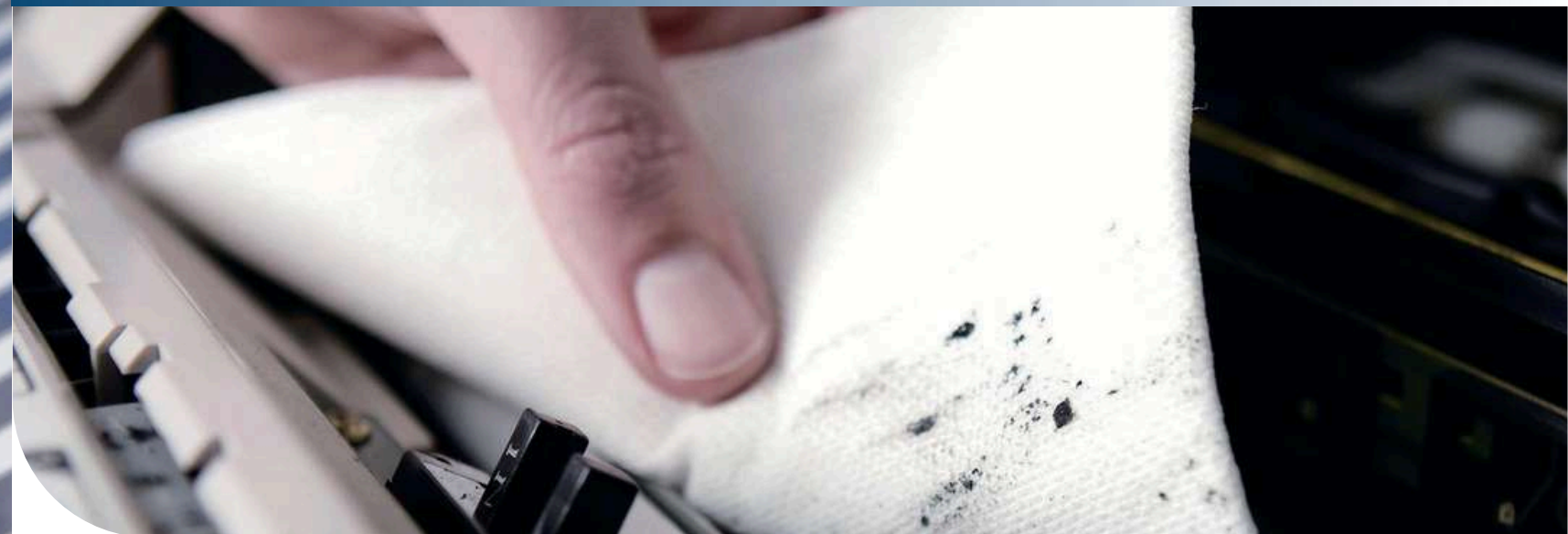

# Cloth Series for Preparation of Surfaces

Specifically designed for spray coating application operations, critical detailing, mechanical maintenance, and more. Applications:

1. Automotive manufacturing
2. Aerospace industry
3. Rail transport
4. Electrical and other equipment

## Surface Preparation Cloth Series

The unique mesh structure allows for the rapid and effective removal of dust particles and adhesives. Its high tear resistance makes it suitable for a variety of heavy-duty cleaning applications. Excellent absorption and cleaning power ensure high work efficiency. Lint shedding is extremely low, and it generates virtually no dust, meeting the requirements of critical process environments. It is versatile for both wet and dry use and compatible with various solvents.



### Product Specifications

Name of the Product	Model of the Product	Color	Size	Packing
Microfiber cloths	W3101	Blue	40×40 cm	25 pieces/box
	W3102	Blue	30×30 cm	10 cloths/bag, 12 bags/box
	W3204	White	40×80 cm	20 pieces/pack, 25 packs/box
Adhesive bandages	W3201	White	22×42 cm	10 pieces/pack, 4 packs/box
	W3202	White	22×42 cm	30 pieces/pack, 20 packs/box
	W3203	White	22×30 cm	100 pieces/pack, 4 packs/box
Remover cloths	W3301	White	25×40 cm	50 pieces/pack, 20 packs/box
	W3303	White	50×40 cm	500 pieces/box
Ultra-soft cloths	W3401	White	25×30 cm	100 pieces/box, 6 boxes/case
	W3402	White	30×35 cm	240 pieces/box, 4 boxes/case
High-quality cloths endurance	W3501	White	25×30 cm	500 pieces/roll, 4 rolls/case
	W3502	White	30×35 cm	500 pieces/roll, 2 rolls/case



## Universal Series of Cleaning Cloths

Excellent water and oil absorption performance. High wear resistance, soft and flexible, washable and reusable multiple times. Leaves no fibers or lint after cleaning, reducing contamination and rework. Its unique cleaning structure improves efficiency in a single pass.



# Universal Series of Cloths Cleaning

Excellent performance in water and oil absorption, soft and resistant, cleans in one pass.

Applications:

1. Manufacturing and maintenance of transport equipment such as automobiles
2. Rail transport and aeronautics
3. Printing Industry
4. Food processing
5. Metal processing
6. Manufacturing and maintenance of electrical generation equipment and other industries

### Product Specifications

Product Name	Product Model	Color	Size	Packing
Universal Cloth X5	W2101	White	25×35 cm	300 pieces/box
Universal Cloth X6	W2120	White	23×34 cm	500 pieces/roll, 2 rolls/box
	W2201	White	30×35 cm	200 pieces/box
	W2202	White	31×34.5 cm	90 pieces/roll/box
Universal Cloth X7	W2301	Blue	23×42 cm	100 pieces/pack, 8 packages/box
	W2302	Blue	23×34 cm	100 pieces/box, 10 boxes/cases
Universal Cloth X8	W2401	White	31×34 cm	870 pieces/roll/box
	W2402	White	31×34.5 cm	540 pieces/roll/box



# Series of Face masks for Clean Rooms

Personal protective equipment (PPE) for cleanroom environments and other similar critical work areas

### Applications:

1. Electronics
2. Industrial
3. Pharmaceutical
4. Health Sector

## Cleanroom Mask Series

Cleanroom face masks are designed to protect cleanroom environments and the personnel who work in them. The three-layer protective mask offers excellent filtration capabilities, with an outer layer of spunbond polypropylene (ES) material that effectively reduces particle generation, providing comfort to the wearer even during extended periods. Two sizes are available: 210 mm and 180 mm. Each mask features an adjustable nose clip and ultrasonically welded ear loops for durability and cleanliness.



### Product Specifications

Name of the Product	Model of the Product	Layers	Material	Size	Packing	Type of Subjection
Face masks for Clean Rooms	F1001	3 layers	IS	9×18 cm	100 pieces/bag, 10 bags/box	PU earband
	F1102	3 layers	IS	9×21 cm	100 pieces/bag, 10 bags/box	PU earband
	F1103	3 layers	IS	9×18 cm	100 pieces/bag, 10 bags/box	CP earband
	F1201	3 layers	IS	9×18 cm	100 pieces/bag, 10 bags/box	Headband PU
	F1202	3 layers	IS	9×21 cm	100 pieces/bag, 10 bags/box	Headband PU
	F1301	3 layers	IS	9×18 cm	100 pieces/bag, 10 bags/box	Fastening with straps



### Industrial Mask Series

Our industrial face masks are made with high-efficiency filtration materials that effectively filter airborne particles. They are also effective at preventing nasal and oral droplets from contaminating the production environment.



# Series of Masks Industrialists

Provides comprehensive respiratory protection  
**Applications:**  
 • Normal working environments

#### Product Specifications

Name of the Product	Model of the Product	Layers	Material	Size	Packing	Type of Subjection
Masks Industrialists	F2101	3 layers	SBPP	9×18 cm	50 pieces/bag, 20 bags/box	Band of OP ear
	F2201	3 layers	SBPP	9×18 cm	50 pieces/bag, 20 bags/box	Band of OP head

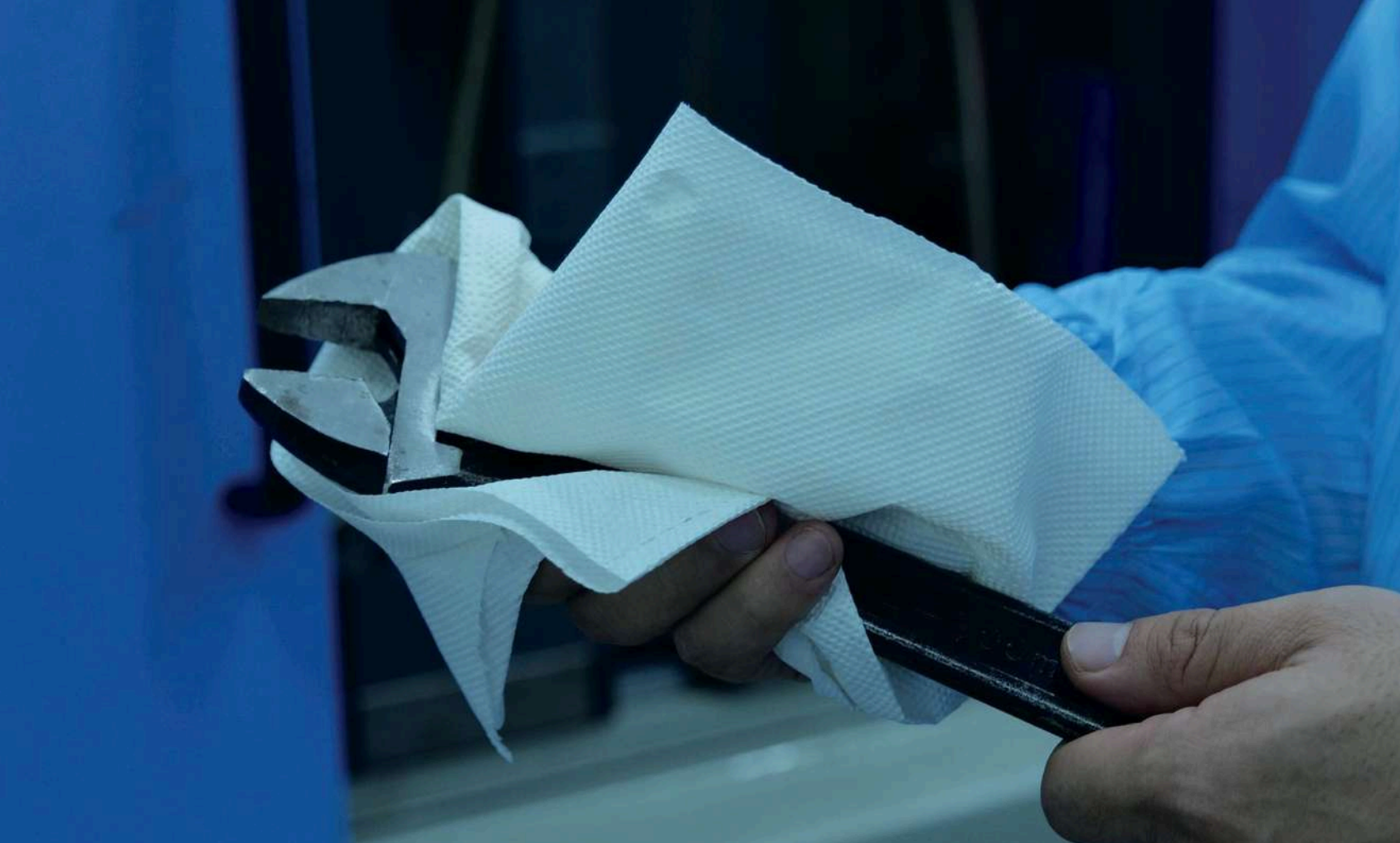

# Standard Series of Cloths Cleaning

100% virgin cellulose, low linting, excellent water and oil absorption

## Applications:

1. Precision machinery manufacturing
2. Metal processing
3. Manufacture of transport equipment
4. Food processing and other industries

## Standard Series of Cleaning Cloths

Our standard cloths are made from 100% virgin cellulose. They offer high absorbency for both water and oil, improving cleaning efficiency. They are strong when dry and maintain their strength even when wet, making them suitable for use with solvents. Thanks to their low particle generation, they do not contaminate the cleaned surface. The multi-layered embossed design increases friction for more effective cleaning. Available in foldable designs and large rolls, providing practical and economical options.



### Product Specifications

Name of the Product	Model of the Product	Color	Size	Packing
Standard L1 Cloths	P2101	White	18×38 cm	789 sheets/roll, 6 rolls/box
	P2102	White	25×40 cm	1250 sheets/roll, 4 rolls/box
Standard L2 Cloths	P2201	Yellow	24×40 cm	550 sheets/roll, 4 rolls/box
	P2202	Yellow	27×27.5 cm	60 sheets/pack, 24 packs/box
	P2203	White	23.5×34 cm	500 sheets/roll, 2 rolls/box
Standard L3 cloths	P2301	Yellow	24×40 cm	420 sheets/roll, 2 rolls/box
	P2302	Yellow	27×27.5 cm	60 sheets/pack, 24 packs/box



## Efficient Cleaning Cloth Series

Our efficient cloths are made from 100% cellulose. Thanks to our special processing techniques, this industrial cleaning paper is soft, fluffy, and has a thick feel. Its unique structure allows it to quickly absorb liquids like a sponge, offering excellent absorption of both water and oil. It has exceptional strength in both dry and wet conditions, making it resistant to damage during use. This cloth is lint-free during cleaning, thus improving the efficiency of the process.



# Cloth Series Efficient Cleaning

Thick and soft material, excellent performance in water and oil absorption.

### Applications:

1. Production and maintenance of gears and bearings
2. Manufacture and maintenance of transport equipment
3. Food processing
4. Medical equipment
5. Printing and other industries

### Product Specifications

Name of the Product	Model of the Product	Color	Size	Packing
Efficient L4 Cloths	P3101	White	31.8×34 cm	750 sheets/roll/box
	P3102	White	31×35 cm	56 pieces/package, 18 packs/box



# Cloth Series Humid Degreasers

Ideal choice for removing tough stains

### Applications:

1. Manufacturing and maintenance of transport equipment
2. Petrochemical industry
3. Printing and other industries

## Degreasing Wet Wipes Series

Double-sided design to meet different cleaning needs, with a special spunlace process to increase friction and easily remove tough stains. Smooth surface for final cleaning and hand contact, eliminating the need for harsh solvents. Its unique cleaning formula ensures a deep clean without additional products and contains no harmful substances. It leaves no residue after use, reducing rework and improving efficiency. The single-pull design effectively controls usage.



### Product Specifications

Name of the Product	Model of the Product	Color	Size	Packing
Meltblown non-woven fabric with design plain knit	G1101	White	16×30.5 cm	180 sheets/roll; 6 rolls/box/bucket
Wet wipes multipurpose	G1102	White	23×28 cm	40 sheets/pack; 10 packages/box
	G1201	Blue	27×27 cm	20 sheets/pack; 20 packages/box
	G1202	Blue	27×27 cm	90 sheets/bucket; 6 buckets/box

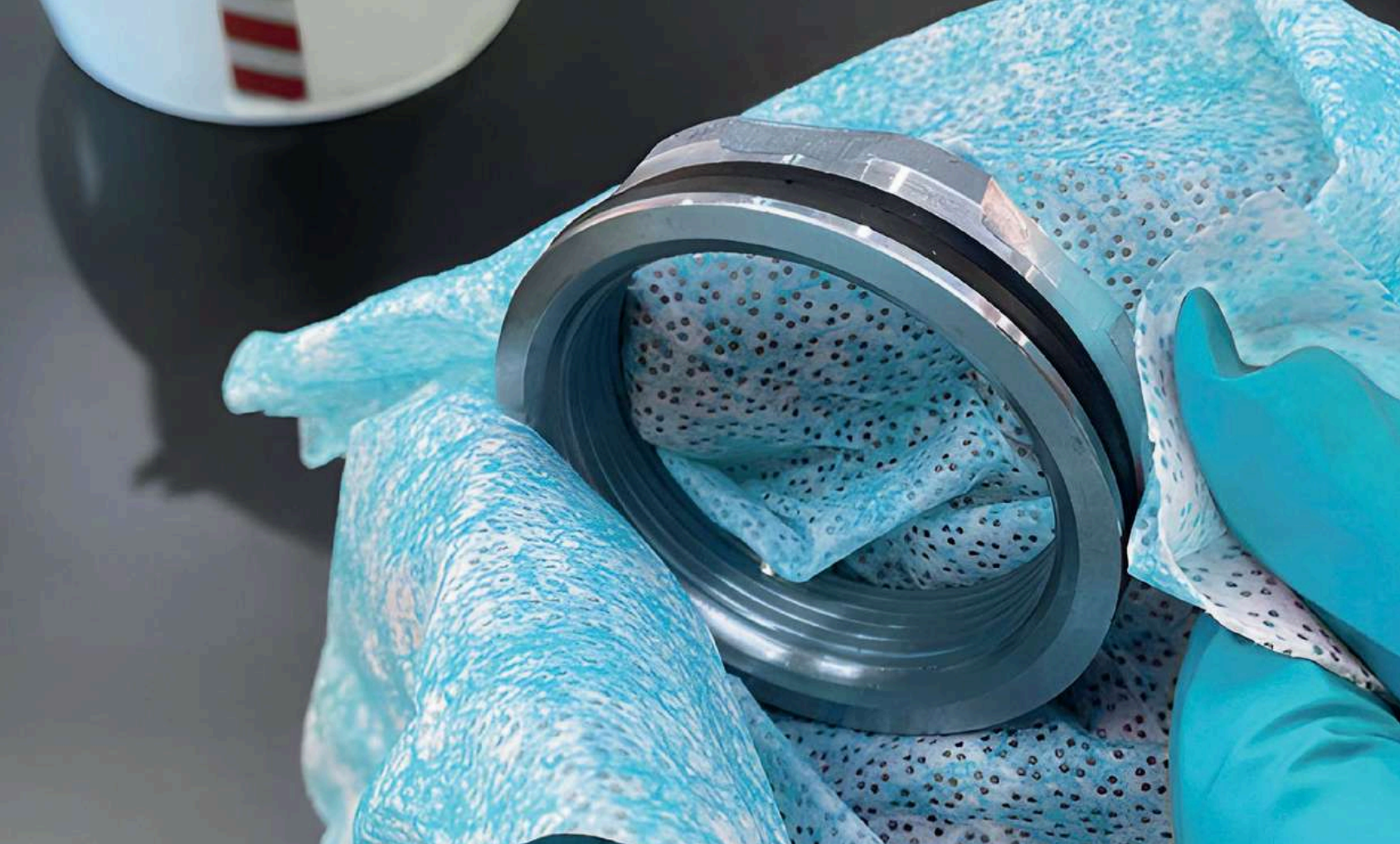

## Delicate Task Cloth Series

These delicate cloths are made from 100% virgin cellulose, with a pure texture and excellent water absorption capacity. They produce minimal dust and are highly resistant to both wet and dry conditions. They are durable and save considerable cleaning time. Soft and gentle, they won't damage or scratch the cleaned surface. These cloths also have antistatic properties, effectively preventing static electricity and dust generation during use, which facilitates specific applications.



# Cloth Series for Tasks Delicate

100% virgin cellulose, ultra low shedding, resistant in dry and wet conditions

### Applications:

1. Optical and laboratory instruments
2. Medical and pharmaceutical industry
3. Fiber optics and other industries

### Product Specifications

Product Name	Product Model	Color	Size	Packing
Cloths for tasks delicate	P1101	White	11×21 cm	280 sheets/box; 60 boxes/cases
	P1102	White	37×42 cm	140 sheets/box; 15 boxes/cases
	P1103	White	22×30 cm	400 sheets/roll; 12 rolls/case
	P1104	White	25×35 cm	1000 sheets/roll; 4 rolls/case
	P1105	White	30×30 cm	119 sheets/box; 15 boxes/cases



# Cloth Series Wet for Cleanrooms

Resealable packaging, consistent solvent saturation, improved cleaning efficiency

### Applications:

1. Biomedical equipment and medical devices
2. Electronic Optics
3. Automotive
4. Aeronautics
5. Printing and other industries

## Cleanroom Wipe Series

- The lint-free fabric features advanced edge-sealing technology to minimize the generation and release of particles.
- Consistent pre-humidified humidity levels and composite evaporation standards ensure continuous, high-quality performance.
- Cleaned and packaged in a cleanroom environment, it has ultra-low ion content and non-volatile residues, suitable for critical cleaning.
- Packaged in resealable bags for ease of use, to reduce solvent evaporation and ensure consistent humidity levels.
- Available in sterile and non-sterile options to meet high-performance requirements in demanding environments.



Name of the Product	Model of the Product	Color	Size	Packing
Melt-blown cloths non-knitted fabrics plum	G2101	White	23×28 cm	40 sheets/pack
Polyester Cloths	G2201	White	23×23 cm	50 sheets/pack
Non-woven fabrics made of polyester cellulose	G2301	White	23×23 cm	50 sheets/pack

V O A D

I N T E R N A T I O N A L G R O U P



## VMC White Round Mouth Static Mixer

The VMC static mixer is applied to AB glue cartridges of 200ml, 400ml, 600ml and 1500ml.

Specially designed according to fluid core science, allowing for simple and efficient operation.

VMC is applicable in 1:1 and 2:1 ratios.

VMCX is applicable in ratios of 4:1 and 10:1.

The interface size is 15.9 mm.



## Parameters: Length (mm) Volume: ml

Number of product	ID	OD	Items	Length	Top ID	Volume
Vmc05-18	5	8	18	121	1.5	2.1
Vmc05-24	5	8	24	149	1.5	23
Vmc05-32	5	8	32	188	1.5	2.8
Vmc06-18	6.3	10	18	149	1.9	3.6
Vmc06-24L	6.3	10	24	185	2.0	4.2
Vmc06-32	6.3	10	32	234.5	1.9	6.6
Vmc08-18	8	12	18	178	2.4	6.7
Vmc08-24	8	12	24	223	2.4	8.6
Vmc08-32	8	12	32	287	2.4	11.8
Vmc10-18	10	14	18	214	3	12.5
Vmc10-24	10	14	24	276	3	15
Vmc10-32	10	14	32	352	3	21.5
Vmc13-24	13	17	24	293.5	4	27.5
Vmc13-32	13	17	32	379	4	35.6
Vmcx08-18	8	12	18	182	2.4	6.9
Vmcx08-24	8	12	24	230	2.4	8.5
Vmcx10-24	10	14	24	275	3	14.6



## VME/VMS Yellow Round Mouth Static Mixer

The VME/VMS static mixer utilizes advanced production principles and high-precision manufacturing technology. The product is suitable for automatic mixing machines. Processes can be automated and continuous, saving time and improving quality.

The upper ID of VMS is 15.9 mm, the upper ID of VME is 16.7 mm.



### Parameters: Length (mm) Volume: ml

Number of product	ID	OD	Items	Length	Top ID	Volume
Vme/s05-24	5.4	8	24	148.5	1.5	23
Vme/s05-32	5.4	8	32	188	1.5	2.8
Vme/s06-24	6.3	10	24	186	1.8	4.0
Vme/s06-32	6.3	10	32	235	1.8	6.5
Vme/s06-48	6.3	10	48	334	2.4	10
Vme/s06-56	6.3	10	56	375	2.4	10.8
Vme/s08-24	8	12	24	223	2.4	8.6
Vme/s08-32	8	12	32	287	2.4	11.6
Vme/s10-12	10	13.5	12	156	3	9.6
Vme/s10-18	10	13.5	18	185	3	12.5
Vme/s10-24	10	13.5	24	275	3	16
Vme/s10-32	10	13.5	32	351	3	23
Vme/s13-24	13	16	24	293	4	27
Vme/s13-32	13	16	32	379	4	34.3



## VMR static dynamic mixer

The VMR dynamic static mixer is applied to automatic dual liquid mixing equipment.

High-speed core rotation, suitable for low-viscosity materials and two-liquid mixtures. The core is removable and reusable.

Parameters: Length (mm) Volume: ml

Number of product	ID	OD	Elements	Length	ID superior	Volume
Vmr06-12	6.4	10	12	110	1.8	-
Vmr08-12	8	12	12	130	2.4	-
Vmr10-12	10	14	12	155	3	-
Vmr13-12	13	17	12	197	4	-
Vmr12-16	12	16	16	128	3	-
Vmr12-26	12	16	26	182	4.5	-
Vrs9-16	9	12	16	102	3	-
Vrs12-16	12	16	16	128	4.5	-

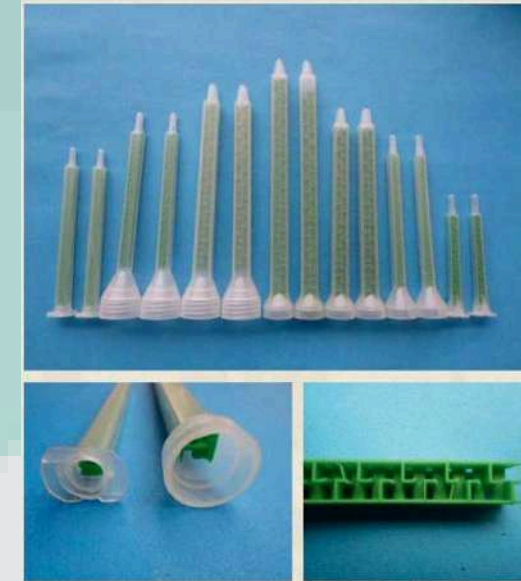

## VMT Square Static Mixer

The VMT square static mixer is an improvement made to the circular static mixer.

The element's shape is alternating. Commonly used in structural adhesives and in the construction industry.

Parameters: Length (mm) Volume: ml

Number of product	ID	OD	Elements	Length	ID superior	Type of Volume connector
Vmt6-16	5.3	7.0	16	83	2.0	卡口 1.3
Vmt6-24	5.3	7.0	24	115	2.0	卡口 2.1
Vmt6-24r	5.3	7.0	24	128	2.0	喷嘴口 2.9
Vmt6-24e	5.3	7.0	24	141	2.0	喷嘴口 3.0
Vmt8-24	8.7	11.5	24	147	4.0	喷嘴口 8.3
Vmt8-32	8.7	11.5	32	183	4.0	喷嘴口 9.5
Vmt8-24e	8.7	11.5	24	162.5	4.0	喷嘴口 9.8

# AB COMPONENT CARTRIDGE

## AB VS Component Cartridge

The AB VS component cartridge is applied to the storage and packaging of two-component liquids.

It is used with glue guns and is compatible with VMA and VMC static mixers.

It can be used for dispensing small quantities.

It can be divided into sizes of 50ml, 200ml, 400ml, 600ml and 1500ml.

The available ratios are: 1:1, 2:1, 3:1, 4:1, 5:1, 10:1.

Number of product	Relationship	Diameter A	Diameter B	Length
Vs-50-11	1:1	21.5mm	21.5mm	100mm
Vs-50-12	2:1	25mm	18mm	100mm
Vs-50-14	4:1	25mm	14mm	100mm
Vs-50-110	10:1	25mm	10mm	100mm
Vs-50-11r	1:1	22mm	22mm	125mm
Vs-50-12r	2:1	25mm	18mm	125mm
Vs-50-14r	4:1	31.5mm	14mm	125mm
Vs-50-110r	10:1	31.5mm	11mm	125mm



# DISPENSING SYRINGES

Glue dispensing syringes are the container used during dispensing.

They use a straight design without taper and are adjusted with the piston, achieving a hermetic seal inside the syringe barrel.

They leave no glue residue and can be divided into sizes of 3cc, 5cc, 10cc, 30cc, 55cc and 70cc.

The available types are classified according to US and Japanese standards.

You can choose between options with or without UV protection.



## 1. US type dispensing syringes.

No.	Length	Diameter internal	Color	Volume
Vsu-3	75mm	9.5mm	Transparent	3cc
Vsu-5	70mm	12.5mm	Transparent	5cc
Vsu-10	90mm	15.5mm	Transparent	10cc
Vsu-30	115mm	22.5mm	Transparent	30cc
Vsu-55	175mm	22.5mm	Transparent	55cc
Vsu-3UV	75mm	9.5mm	Amber/Black/Anti-UV	3cc
Vsu-5UV	70mm	12.5mm	Amber/Black/Anti-UV	5cc
Vsu-10UV	90mm	15.5mm	Amber/Black/Anti-UV	10cc
Vsu-30UV	115mm	22.5mm	Amber/Black/Anti-UV	30cc
Vsu-55UV	175mm	22.5mm	Amber/Black/Anti-UV	55cc



## 2. JP type dispensing syringes

No.	Length	Internal diameter	Color	Volume
Vsj-5	76mm	13.00mm	Transparent	5cc
Vsj-10	104mm	15.50mm	Transparent	10cc
Vsj-30	127mm	23.00mm	Transparent	30cc
Vsj-50	160mm	23mm	Transparent	50cc
Vsj-70	225mm	23mm	Transparent	70cc
Vsj-5UV	76mm	13.00mm	Green	5cc
Vsj-10UV	104mm	15.50mm	Green	10cc
Vsj-30UV	127mm	23.00mm	Green	30cc
Vsj-50UV	160mm	23.00mm	Green	50cc
Vsj-70UV	225mm	23mm	Green	70cc

### 3. Special dispensing syringes



No.	Length	Diameter internal	Color	Volume
Vsm-10	—	—	Transparent	10cc
Vsm-20	—	—	Transparent	10cc
Vsm-30	—	—	Transparent	10cc
Vsm-50	—	—	Transparent	10cc
Vsm-10UV	—	—	Green/Amber	10cc
Vsm-20UV	—	—	Green/Amber	10cc
Vsm-30UV	—	—	Green/Amber	10cc
Vsm-50UV	—	—	Green/Amber	10cc
VSD-100	—	—	Transparent	10cc
VSD-200	—	—	Transparent	10cc
VSD-300	—	—	Transparent	10cc
VSA-6	—	—	Red	6 ounces
Vsm-30	—	—	Steel stainless Steel	30cc
Vsm-55	—	—	stainless	55cc

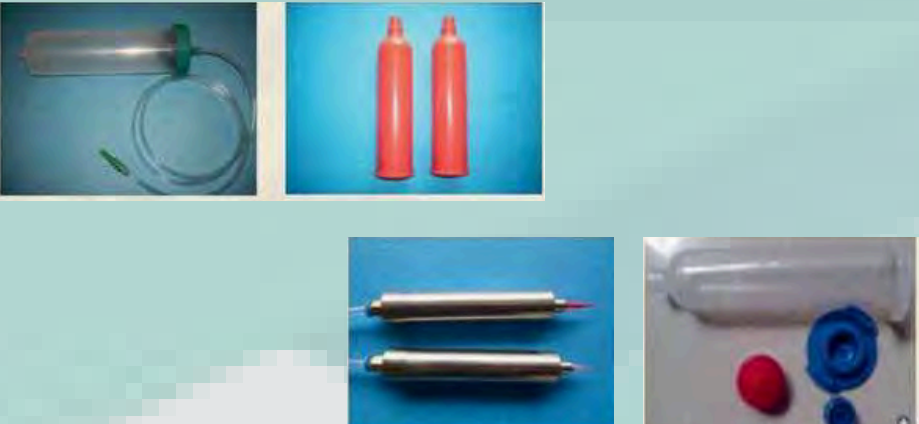

### 4. Syringes

No.	Length	ID	Color	Volume
Vsy-1	-----	—	Transparent	1cc
Vsy-2	-----	—	Transparent	2cc
Vsy-3		—	Transparent	3cc
Vsy-5		—	Transparent	5cc
Vsy-10		—	Transparent	10cc
Vsy-20		—	Transparent	20cc
Vsy-30		—	Transparent	30cc
Vsy-50		—	Transparent	50cc



# NEEDLE SERIES

## 1. Threading needle

The base is made of plastic and the tube is stainless steel. Precision polished, burr-free, for easy dispensing. Precise, double-threaded design. Easy to disassemble.



Size	ID (mm)	OD (mm)	Color
14G	1.55	2.10	Olive
16G	1.16	1.64	Grey
18G	0.84	1.27	Green
20G	0.60	0.91	Pink
22G	0.41	0.72	Blue
25G	0.26	0.51	Red
27G	0.21	0.41	Orange

**2. TT plastic needle** This TT plastic needle features a double-threaded, tapered thread design. It offers good flowability, is suitable for high-viscosity liquids, and is made of PE, providing UV resistance and preventing electrostatic discharge.



Size	ID (mm)	OD (mm)	Color
14G	1.55	2.1 1.8	Olive
15G	1.37	1.64	Amber
16G	1.16	1.27	Grey
18G	0.84	0.91	Green
20G	0.60	0.82	Pink
21G	0.51	0.72	Purple
22G	0.41	0.64	Blue
23G	0.36	0.51	Orange
25G	0.26	0.41	Red
27G	0.21	0.31	Transparent
30G	0.16	0.23	Light purple
32G	0.11	0.19	Yellow
34G	0.06		Lilac

## 3. Dispensing needle Teflon

High fluidity, suitable for fast-setting adhesives.



Size	ID (mm)	OD (mm)	Color
14G	—	—	—
16G	—	—	—
18G	—	—	—
20G	—	—	Grey
22G	0.60	1.60	—
25G	0.26	1.15	Pink
27G	0.21	1.10	Red



## 4. PP Entangled Dispensing Needle

Made with special materials, the needle has a high tenacity and can prevent scratching the product surface. The needle length can adjust.

Size	ID (mm)	OD (mm)	Color	Size
14G	1.55	1.80	Olive	14G
15G	1.37	1.80	Amber	15G
18G	0.84	1.27	Green	18G
20G	0.60	0.91	Pink	20G
22G	0.41	0.72	Blue	22G
25G	0.26	0.51	Red	25G

## 5. Stainless steel dispensing needle

Precision manufacturing of high-quality dispensing needles. Resistance to corrosion, resistant heavy work, applicable to High-speed, high-precision, and automatic dispensing machines. High-precision polishing.



Size	ID (mm)	OD (mm)	Size	ID (mm)
12G	2.27	2.77	12G	2.27
13G	1.94	2.40	13G	1.94
14G	1.55	2.10	14G	1.55
15G	1.37	1.80	15G	1.37
16G	1.16	1.64	16G	1.16
17G	1.01	1.49	17G	1.01
18G	0.84	1.27	18G	0.84
19G	0.70	1.08	19G	0.70
20G	0.60	0.91	20G	0.60
21G	0.51	0.82	21G	0.51
22G	0.41	0.72	22G	0.41
23G	0.34	0.64	23G	0.34
24G	0.30	0.58	24G	0.30
25G	0.26	0.51	25G	0.26
26G	0.23	0.46	26G	0.23
27G	0.21	0.41	27G	0.21
30G	0.16	0.31	30G	0.16
Size	ID (mm)	OD (mm)	Size	ID (mm)
12G	2.27	2.77	12G	2.27

## 6. Special Needle



# SYRINGE ACCESSORIES

**1. Syringe adapter** The connection between the syringe barrel and the dispensing machine. It connects to the air compressor for operation and is very durable. It is available in US and Japanese models. Available sizes are 3cc, 5cc, 10cc, 30cc, and 55cc.

Size	Compatible syringe	Color
Vsu-3	US3cc	White/green/yellow/black
Vsu-5	US5cc	White/green/yellow/black
Vsu-10	US10cc	White/green/yellow/black
Vsu-30	US30cc/55cc	White/green/yellow/black
Vsj-5	Japan 5cc	Green
Vsj-10	Japan 10cc	Green
Vsj-30	Japan 30cc/50cc	Green
VSM-10	Musashi 10cc	White
VSM-30	Musashi 30cc	White



## 2 Other syringe accessories Metal

- adapter connector,
- transparent needle boxes,
- barrel cap and cover, AB glue
- tee



VOAD

INTERNATIONAL GROUP